

KOSHIN



GENERAL CATALOG Vol.5

 facebook @koshinpump

 YouTube

Trusted in 160 Countries for



KOSHIN LTD. JAPAN

▼ Explanation of pictogram



GARDENING



IRRIGATION



SPRINKLER



FIRE FIGHTING



WASHING



HIGH LIFT



FISH TANK



ON BOAT



200 L
DRUM CAN



SILICON CARBIDE
MECHANICAL SEAL



CONSTRUCTION



SHALLOW
WELL



FISH FARM

High Quality



HIDELS PUMPS Powered by KOSHIN ENGINE.....	4
SEMI-TRASH PUMPS Powered by KOSHIN ENGINE	7
TRASH PUMPS Powered by KOSHIN ENGINE	8
HIDELS PUMPS Powered by HONDA ENGINE	11
SEMI-TRASH PUMPS Powered by HONDA ENGINE	14
TRASH PUMPS Powered by HONDA ENGINE	15
AGRO MATE (THERMOPLASTIC PUMPS)	17
HIDELS PUMPS / HIGH PRESSURE	18
HIDELS PUMPS Powered by MITSUBISHI ENGINE	20
HIDELS PUMPS Powered by ROBIN(CC) ENGINE	22
HIDELS PUMPS Powered by YANMAR DIESEL ENGINE	23
SEMI-TRASH PUMPS Powered by YANMAR DIESEL ENGINE	24
TRASH PUMPS Powered by YANMAR DIESEL ENGINE	25
PABOOL PUMPS	26
GENERATOR	29
PONSTAR (SUBMERSIBLE PUMPS)	30
PONDY (SUBMERSIBLE PUMPS)	33
PONDY, MARINE PET (SUBMERSIBLE PUMPS).....	34
HIGH PRESSURE WASHER	35
GEAR PUMPS	36
CHANGE MASTER, FS PUMPS	38
FILL PUMPS.....	39
DRUM PUMPS	40
PACO-PET, MAMA-AUTO	42
ECARL (BATTERY WINCHES)	44
MINI-ECARL (BATTERY WINCHES)	47
MINI-ECARL [REP Series] (BATTERY WINCHES)	48
MAG-ROLLER (BATTERY WINCHES)	48
NEW BILGE KING	49
REVOLVEX PUMPS	50
REVOLVEX PUMPS, RUBBER MASTER	52
FS PUMPS	53
BACK PACK TYPE ENGINE SPRAYER	56
ENGINE SPRAYER WITH TANK CARRY	58
ENGINE SPLAYER & PRESSURE WASHER	59
GARDEN SPRAYER (Powered by Electric Motor).....	60
GARDEN SPRAYER (BACK PACK TYPE ENGINE SPRAYER).....	61
GARDEN SPRAYER (Powered by Dry Cell Battery)	62
GARDEN SPRAYER (Manual Sprayer / Powerd by Electric Motor)	63
GARDEN MASTER, GROUND MASTER	64
SMART KOSHIN BATTERY SYSTEM	66
SNOW BLOWER & REMOVER	76



SEA WATER



CHEMICALS



HOME SWIMMING
POOL



OIL
(VISCOSITY)



OIL
TRANSFER



DRY CELL
BATTERY



ENVIRONMENT



PORTABLE & POWERFUL

KOSHIN Engine Competitive Price & Guaranteed Quality

(1) Low fuel consumption. The Koshin engine achieves the lowest fuel consumption.

Low Fuel Consumption (SEV-80X case)

Comparison of Fuel Consumption

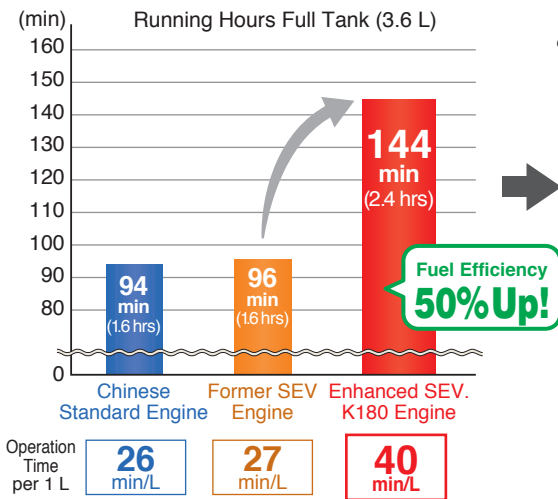

Comparison of Running Cost (Fuel)

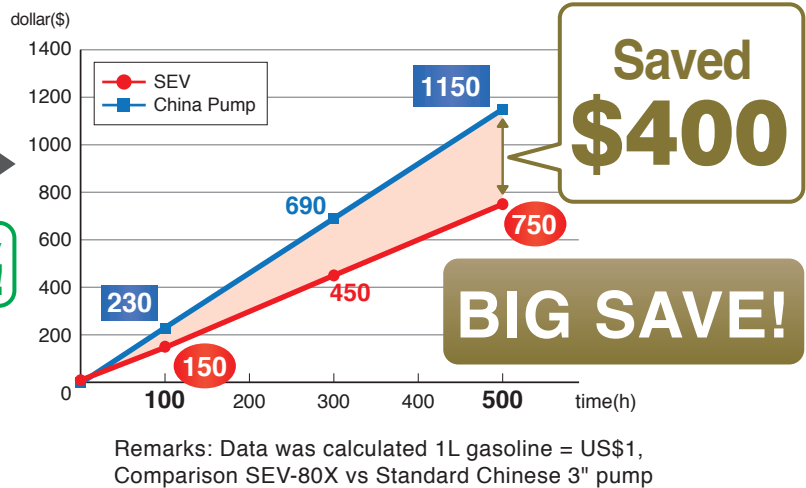

(2) Low Vibration

Comfortable in use after reducing engine vibration.

(3) Guaranteed performance

Koshin guarantees 8 m suction lift and specifications.

Clear Water Pumps



SEV-50X

Performance Curve

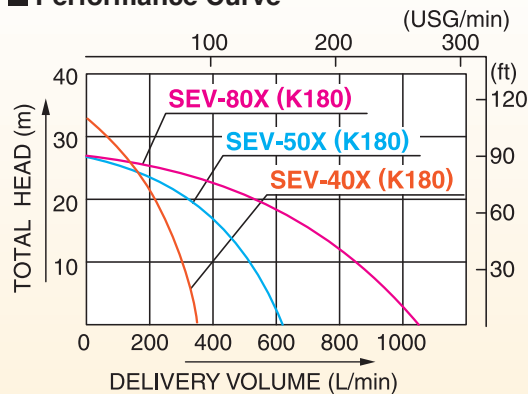

SEV-80X

Specification

Model		SEV-40X*	SEV-50X	SEV-80X
PUMP	Connection Dia	40 mm (1½")	50 mm (2")	80 mm (3")
	Connection Thread	Outer Pipe Thread BSP or NPT		
	Total Head	33 m (108 ft)	27 m (88 ft)	
	Delivery Volume	340 L/min (90 USG/min)	620 L/min (163 USG/min)	1050 L/min (277 USG/min)
	Max. Suction Lift	8 m (26 ft)		
ENGINE	Type	Forced Air-cooled 4-stroke Gasoline Engine		
	Model	Koshin K180		
	Displacement	179 cc		
	Rated Output	3.1 kW (4.2 PS) / 3600 rpm		
	Max. Output	3.5 kW (4.8 PS) / 3600 rpm		
	Fuel	Automotive Unleaded Gasoline		
	Fuel Tank Capacity	3.6 L (0.95 USG)		
	Continuous Operating Time	Approx. 2.6 hrs		Approx. 2.4 hrs
Starting Method		Recoil Starter		
Standard Accessories		1 Strainer, 2 Hose Couplings, 3 Hose Bands, 1 Engine Tool Set		
Net Weight		26.5 kg (58.4 lbs)	25.2 kg (55.5 lbs)	28.7 kg (63.2 lbs)
Gross Weight		29.0 kg (63.9 lbs)	27.2 kg (59.9 lbs)	30.7 kg (67.6 lbs)
Dimensions LxWxH (mm)		554 × 406 × 424	504 × 405 × 411	543 × 425 × 460
Packing Unit		1		

*Japanese Domestic Model

Clear Water Pumps



4
STROKE

SEV-25F

ULTRALIGHT 4-STROKE ENGINE

- EASIER STARTING!
- LESS NOISE!

- Environmentally friendly 4-stroke engine
- Cleaner exhaust emissions
- Less the CO and NOx emissions compared with 2-stroke engine

Performance Curve

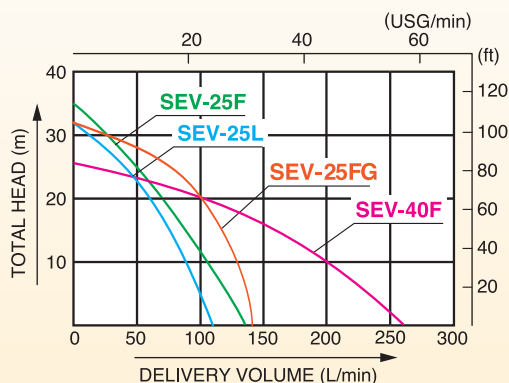

2
STROKE

SEV-25L



4
STROKE

SEV-40F

Specification

Model	SEV-25L	SEV-25F	SEV-25FG*	SEV-40F	
PUMP	Connection Dia	25 mm (1")		40 mm (1½")	
	Connection Thread	Outer Pipe Thread BSP or NPT			
	Total Head	32 m (105 ft)	35 m (115 ft)	32 m (105 ft)	26 m (85 ft)
	Delivery Volume	110 L/min (29 USG/min)	135 L/min (35 USG/min)	140 L/min (32 USG/min)	260 L/min (68 USG/min)
	Max. Suction Lift	8 m (26 ft)			
ENGINE	Type	Forced Air-cooled 2-stroke Gasoline Engine		Forced Air-cooled 4-stroke Gasoline Engine	
	Model	Koshin KC26	Koshin K35	Koshin K100	
	Displacement	26 cc	35.2 cc	98 cc	
	Rated Output	—		1.6 kW (2.2 PS) / 3600 rpm	
	Max. Output	0.75 kW (1.0 PS) / 8000 rpm	0.81 kW (1.1 PS) / 6500 rpm	1.8 kW (2.4 PS) / 3600 rpm	
	Fuel	2-stroke Mixed Gas and Oil (50:1)		Automotive Unleaded Gasoline	
	Fuel Tank Capacity	0.6 L (0.16 USG)	0.73 L (0.19 USG)	1.8 L (0.47 USG)	
	Continuous Operating Time	Approx. 50 min	Approx. 55 min	Approx. 2 hrs	
	Starting Method	Recoil Starter			
Standard Accessories	1 Strainer, 2 Hose Couplings, 3 Hose Bands, 1 Engine Tool Set				
Net Weight	5.5 kg (12.1 lbs)	7.4 kg (16.3 lbs)	18 kg (39.7 lbs)	18 kg (39.7 lbs)	
Gross Weight	6.8 kg (15 lbs)	8.5 kg (18.7 lbs)	20.5 kg (45.2 lbs)	22 kg (48.5 lbs)	
Dimensions LxWxH (mm)	358 x 263 x 323	403 x 266 x 348	490 x 330 x 397	450 x 330 x 397	
Packing Unit	1				

*Japanese Domestic Model

For Sandy and Muddy Water

• **SIC**

Silicon Carbide Mechanical Seal 4-5 times more durable than Standard Carbon Ceramic mechanical seal.



• **FCD**

Spheroidal Graphite Iron Casting for Impeller & Volute Casing 6.5 times more erosion resistance than Standard Cast Iron (FC200)



Solid Sizes

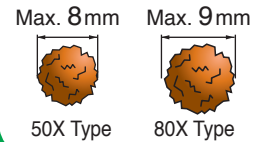

■ **Outstanding Features**

- Suitable for Sandy and Muddy Water usage
- Particles up to 9 mm can be pumped through
- Guaranteed 8 meters suction lift
- Long bolt assembly for easy maintenance

■ **Performance Curve**

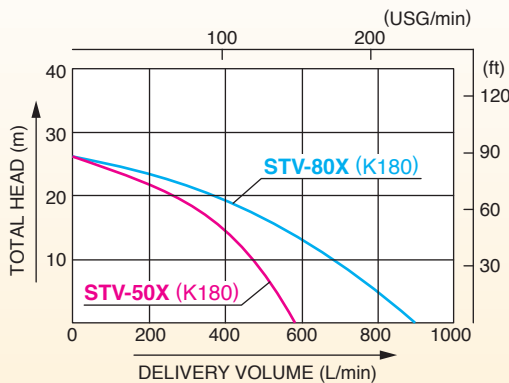

STV-80X

■ **Specification**

Model		STV-50X	STV-80X
PUMP	Connection Dia	50 mm (2")	80 mm (3")
	Connection Thread	Outer Pipe Thread BSP or NPT	
	Total Head	26 m (85 ft)	
	Delivery Volume	580 L/min (153 USG/min)	900 L/min (238 USG/min)
	Max. Suction Lift	8 m (26 ft)	
ENGINE	Type	Forced Air-cooled 4-stroke Gasoline Engine	
	Model	Koshin K180	
	Displacement	179 cc	
	Rated Output	3.1 kW (4.2 PS) / 3600 rpm	
	Max. Output	3.5 kW (4.8 PS) / 3600 rpm	
	Fuel	Automotive Unleaded Gasoline	
	Fuel Tank Capacity	3.6 L (0.95 USG)	
	Continuous Operating Time	Approx. 2 hrs	Approx. 1.6 hrs
	Starting Method	Recoil Starter	
	Standard Accessories	1 Strainer, 2 Hose Couplings, 3 Hose Bands, 1 Engine Tool Set, 1 Spanner	
Net Weight	29 kg (63 lbs)	30.9 kg (68.1 lbs)	
Gross Weight	31 kg (68.3 lbs)	32.9 kg (72.5 lbs)	
Dimensions LxWxH (mm)	554 × 400 × 471	593 × 425 × 528	
Packing Unit	1		



HEAVY DUTY

Koshin Trash Pumps

- **Reasonable price**
About 30% less price compared to same quality trash pumps.
The most affordable price ever.
- **Excellent Quality**
Provides powerful performance and long durability with New KOSHIN engine and enhanced pump.
- **Easy maintenance**
Thoughtful flame for easy replacement of carburetor.
You can clear inside of pump by simply removing pump casing with only one tool.

Easy & Quick Maintenance



Special Material for Koshin Trash Pumps

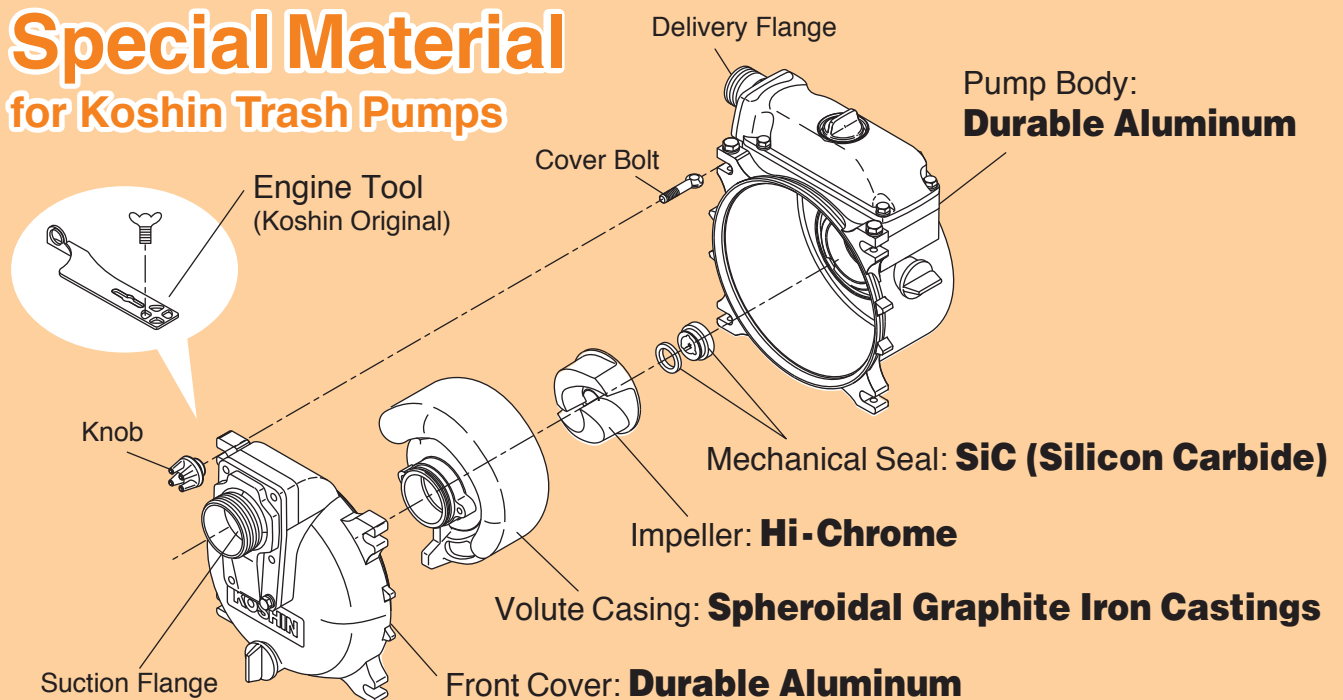

Heavy Duty Trash Pumps



New



KTZ-80X



KTZ-100X

Performance Curve

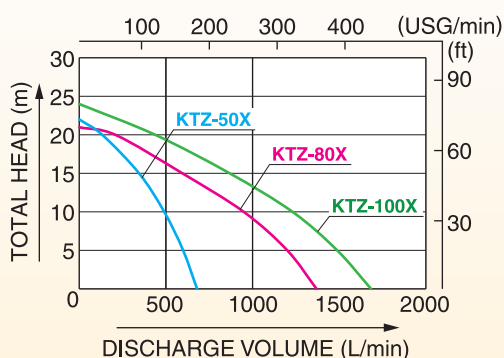

Solid Sizes

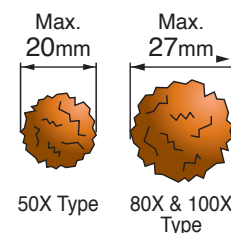

Specification

	Model	KTZ-50X	KTZ-80X	KTZ-100X
PUMP	Connection Dia	50 mm(2")	80 mm(3")	100 mm(4")
	Connection Thread	Outer Pipe Thread BSP or NPT		
	Total Head	22 m (72 ft)	21 m (68 ft)	24 m (78 ft)
	Delivery Volume	680 L/min (179 USG/min)	1370 L/min (361 USG/min)	1680 L/min (443 USG/min)
	Max.Suction Lift	8 m (26 ft)		
	Material for Mechanical Seal	SiC (Silicon Carbide) × SiC		
	Material for Impeller	Hi-Chrome		
Material for Volute	FCD 450			
Type	Forced Air-Cooled 4-stroke Gasoline Engine			
ENGINE	Model	Koshin K180	Koshin K300	Koshin K420
	Displacement	179 cc	301 cc	420 cc
	Rated Output	3.1 kW (4.2PS) / 3600 rpm	5.0 kW (6.8 PS) / 3600 rpm	7.2 kW (9.8 PS) / 3600 rpm
	Max. Output	3.5 kW (4.8PS) / 3600 rpm	6.0 kW (8.2 PS) / 3600 rpm	8.6 kW (11.7 PS) / 3600 rpm
	Fuel	Automotive Unleaded Gasoline		
	Fuel Tank Capacity	3.6 L (0.95 USG)	5.9 L (1.5 USG)	5.9 L (1.5 USG)
	Continuous Operating Time	Approx. 2.0 hrs		Approx. 1.5 hrs
	Starting Method	Recoil Starter		
	Standard Accessories	1 Strainer, 3 Hose Bands, 1 Engine Tool Set, 1 Multi Tool Wrench (BSP Type: 2 Hose Couplings)		
Net Weight	48.1 kg (106.0 lbs)	61.6 kg (135.8 lbs)	78.2 kg (172.4 lbs)	
Gross Weight	54 kg (119 lbs)	68.4 kg (150.8 lbs)	88.0 kg (194.0 lbs)	
Dimensions L×W×H (mm)	703 × 579 × 542	726 × 579 × 603	816 × 621 × 632	
Packing Unit	1			

New Design with Easy Maintenance

Powered by KOSHIN K300 & K420

- The front cover can be removed easily without removing hoses
- Handles on the front cover can be installed in vertical or horizontal position
- Easy removal of knobs
- New Impeller design with hexagon boss for easy installation and removal



KTZ-80S

Performance Curve

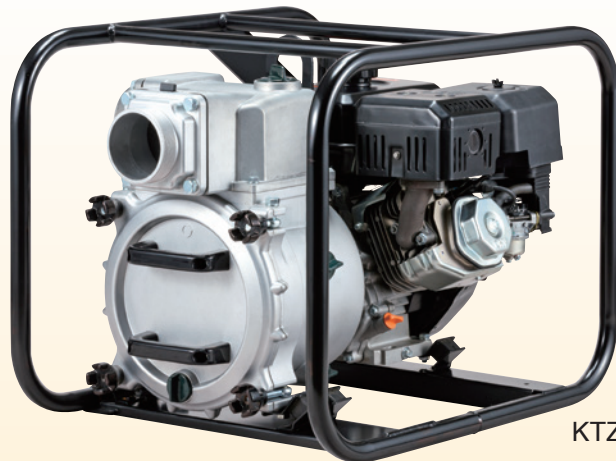
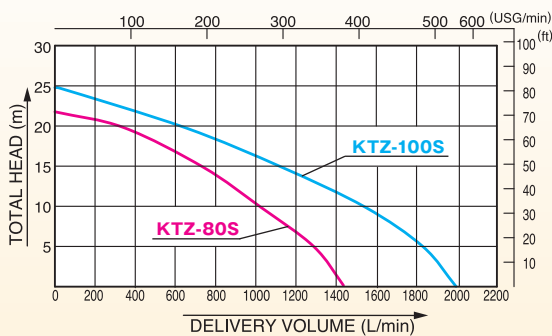

KTZ-100S

Specification

Model		KTZ-80S	KTZ-100S
PUMP	Connection Dia	80 mm(3")	100 mm(4")
	Connection Thread	Outer Pipe Thread BSP or NPT	
	Total Head	22 m (72 ft)	25 m (82 ft)
	Delivery Volume	1420 L/min (375 USG/min)	1980 L/min (523 USG/min)
	Max.Suction Lift	8m (26 ft)	
	Material for Mechanical Seal	SiC (Silicon Carbide) x SiC	
	Material for Impeller	Hi-Chrome	
Material for Volute	FCD450		
ENGINE	Type	Forced Air-Cooled 4-stroke Gasoline Engine	
	Model	Koshin K300	Koshin K420
	Displacement	301cc	420cc
	Rated Output	5.0 kW (6.8 PS) / 3600 rpm	7.2 kW (9.8 PS) / 3600 rpm
	Max. Output	6.0 kW (8.2 PS) / 3600 rpm	8.6 kW (11.7 PS) / 3600 rpm
	Fuel	Automotive Unleaded Gasoline	
	Fuel Tank Capacity	5.9L (1.5 USG)	
	Continuous Operating Time	Approx. 2 hrs	Approx. 1.5 hrs
	Starting Method	Recoil Starter	
	Standard Accessories	1 Strainer, 3 Hose Bands, 1 Engine Tool Set, 1 Multi Tool wrench (BSP Type: 2 Hose Couplings)	
Net Weight	65.3 kg (144.0 lbs)	81.2 kg (179.0 lbs)	
Gross Weight	72.6 kg (160.1 lbs)	90.5 kg (199.5 lbs)	
Dimensions LxWxH (mm)	729 x 589 x 602	800 x 621 x 624	
Packing Unit	1		

Environment Friendly Low Noise

* Engine noise are half of 2-stroke engine.

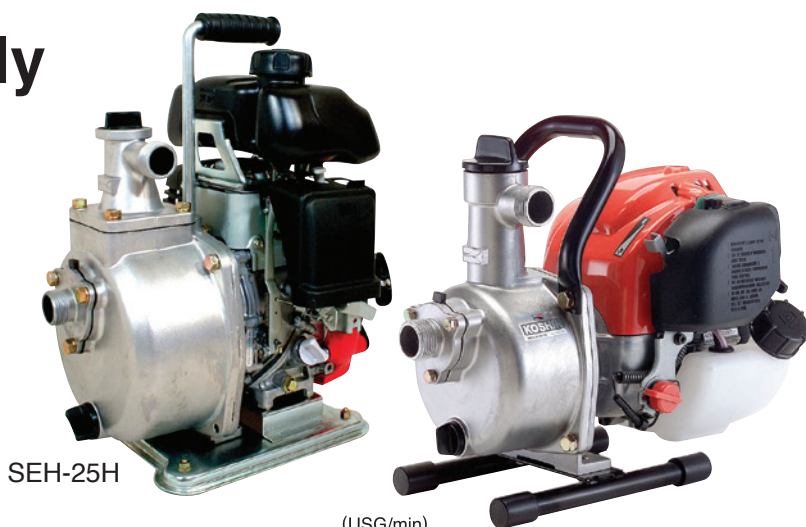

SEH-25H

SEH-25L

Performance Curve

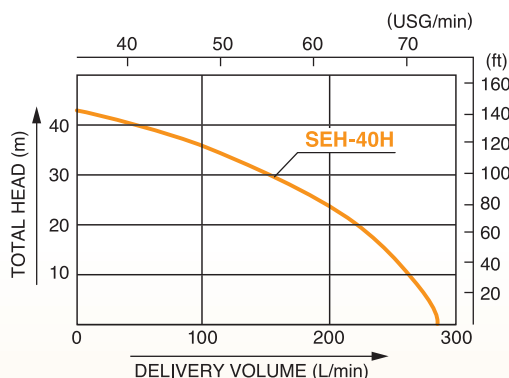
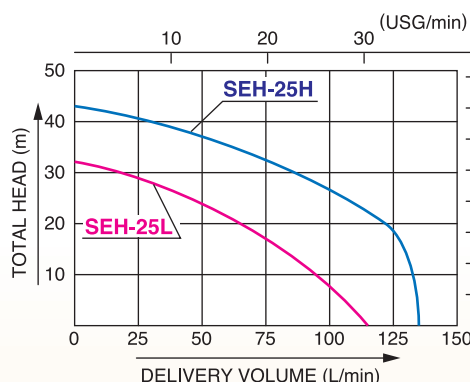

Available 25 mm Hose Set

N-Type Hose Set

- Washing of agriculture & construction machinery



- 1 Discharge hose <8 m (26 ft)>
- 1 Nozzle (Jet)

R-Type Hose Set

- Washing of agriculture machinery
- Water sprinkling to the field



- 1 Discharge hose <8 m (26 ft)>
- 1 Nozzle (Jet & Mist)

New Spray Nozzle



SJ-20

- Large volume of spraying water

- 1 Coupling set <20 mm (3/4")>
- 1 Hose nipple <20 mm (3/4") x 15 mm (1/2")>



Specification

	Model	SEH-25L	SEH-25H	SEH-40H
PUMP	Connection Dia	25 mm (1")		40 mm (1 1/2")
	Connection Thread	Outer Pipe Thread BSP or NPT		
	Total Head	32 m (105 ft)	43 m (141 ft)	43 m (141 ft)
	Delivery Volume	115 L/min (30 USG/min)	135 L/min (36 USG/min)	280 L/min (73 USG/min)
	Max. Suction Lift	8 m (26 ft)		
ENGINE	Type	Forced Air-cooled 4-stroke Gasoline Engine		
	Model	Honda GX25		Honda GXH50
	Displacement	25 cc		49.4 cc
	Rated Output	—		
	Max. Output	0.72 kW (1.0 PS) / 7000 rpm	1.6 kW (2.2 PS) / 7000 rpm	1.8 kW (2.4 PS) / 7000 rpm
	Fuel	Automotive Unleaded Gasoline		
	Fuel Tank Capacity	0.53 L (0.14 USG)	0.77 L (0.20 USG)	
	Continuous Operating Time	Approx. 1 hr		Approx. 2 hrs
	Starting Method	Recoil Starter		
	Standard Accessories	1 Strainer, 2 Hose Couplings, 3 Hose Bands, 1 Engine Tool Set		
Net Weight	5.5 kg (12.1 lbs)		11.5 kg (25.4 lbs)	
Gross Weight	7 kg (15.4 lbs)		13.5 kg (29.7 lbs)	
Dimensions LxWxH (mm)	375 x 243 x 320		455 x 302 x 447	
Packing Unit	1			

Complete Range of Water Pumps Powered by Honda Engine



Performance Curve

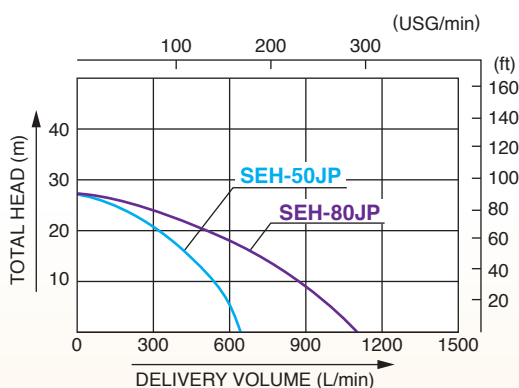

SEH-50JP

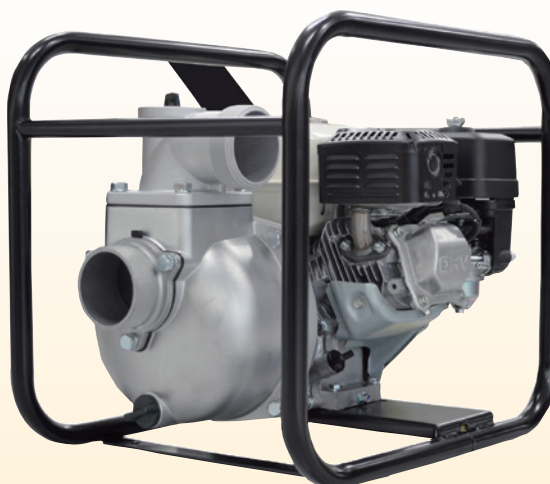

SEH-80JP

Specification

Model		SEH-50JP	SEH-80JP
PUMP	Connection Dia	50 mm (2")	80 mm (3")
	Connection Thread	Outer Pipe Thread BSP	
	Total Head	27 m (88 ft)	
	Delivery Volume	640 L/min (169 USG/min)	1100 L/min (290 USG/min)
	Max. Suction Lift	8 m (26 ft)	
ENGINE	Type	Forced Air-cooled 4-stroke Gasoline Engine	
	Model	Honda GP160	
	Displacement	163 cc	
	Rated Output	2.9 kW (3.9 PS) / 3600 rpm	
	Max. Output	3.6 kW (4.9 PS) / 3600 rpm	
	Fuel	Automotive Unleaded Gasoline	
	Fuel Tank Capacity	3.1 L (0.8 USG)	
	Continuous Operating Time	Approx. 2.5 hrs	Approx. 2.2 hrs
	Starting Method	Recoil Starter	
	Standard Accessories	1 Strainer, 2 Hose Couplings, 3 Hose Bands, 1 Engine Tool Set	
Net Weight	24 kg (52.9 lbs)	27.3 kg (60.2 lbs)	
Gross Weight	26 kg (57.3 lbs)	30 kg (66.0 lbs)	
Dimensions LxWxH (mm)	504 x 401 x 406	525 x 389 x 458	
Packing Unit	1		

Complete Range of Water Pumps Powered by Honda Engine



Performance Curve

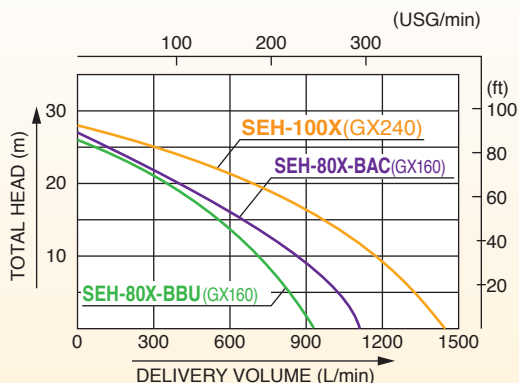
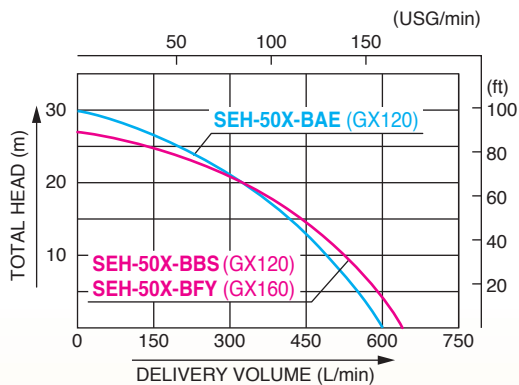

SEH-50X



SEH-80X

Specification

Model	SEH-50X-BAE	SEH-50X-BBS	SEH-50X-BFY	SEH-80X-BBU	SEH-80X-BAC	SEH-100X
Connection Dia	50 mm (2")			80 mm (3")		100 mm (4")
Connection Thread	Outer Pipe Thread BSP or NPT					
Total Head	30 m (98 ft)	27 m (88 ft)		26 m (85 ft)	27 m (88 ft)	28 m (92 ft)
Delivery Volume	600 L/min (158 USG/min)	640 L/min (169 USG/min)		930 L/min (246 USG/min)	1100 L/min (290 USG/min)	1450 L/min (383 USG/min)
Max. Suction Lift	8 m (26 ft)					
Impeller	FC200					
Volute Casing	ADC12	FC200		ADC12	FC200	
Type	Forced Air-cooled 4-stroke Gasoline Engine					
Model	Honda GX120			Honda GX160		Honda GX240
Displacement	122 cc			163 cc		270 cc
Rated Output	2.1 kW (2.9 PS) / 3600 rpm			2.9 kW (3.9 PS) / 3600 rpm		4.6 kW (6.3 PS) / 3600 rpm
Max. Output	2.4 kW (3.3 PS) / 3600 rpm			3.6 kW (4.9 PS) / 3600 rpm		5.9 kW (8.0 PS) / 3600 rpm
Fuel	Automotive Unleaded Gasoline					
Fuel Tank Capacity	2.0 L (0.53 USG)			3.1 L (0.82 USG)		5.3 L (1.4 USG)
Continuous Operating Time	Approx. 2 hrs					Approx. 2.5 hrs
Starting Method	Recoil Starter					
Standard Accessories	1 Strainer, 2 Hose Couplings, 3 Hose Bands, 1 Engine Tool Set					
Net Weight	21 kg (46.3 lbs)	21 kg (46.3 lbs)	25.2 kg (56.2 lbs)	27 kg (59.5 lbs)	28 kg (61.7 lbs)	54 kg (119 lbs)
Gross Weight	22 kg (48.5 lbs)	23 kg (50.7 lbs)	27.2 kg (59.9 lbs)	30 kg (66.0 lbs)		59 kg (130 lbs)
Dimensions LxWxH (mm)	483 x 375 x 376		504 x 401 x 406	525 x 389 x 458	525 x 389 x 463	680 x 490 x 675
Packing Unit	1					

Economical Trash Pumps For Sandy & Muddy Water

- **Silicon Carbide Mechanical Seal (SiC).**
4 to 5 times more durable than standard Carbon Ceramic Mechanical Seal.
- Spheroidal graphite iron casting (FCD 450) for Impeller and Casing.
6.5 times more corrosion resistant than standard FC or Cast Iron.
- Impeller can be removed easily without special tool.
- Long bolt assembly for easy maintenance.



Solid Sizes

Max. 8mm



50X Type

Max. 9mm



80X & 100X Type

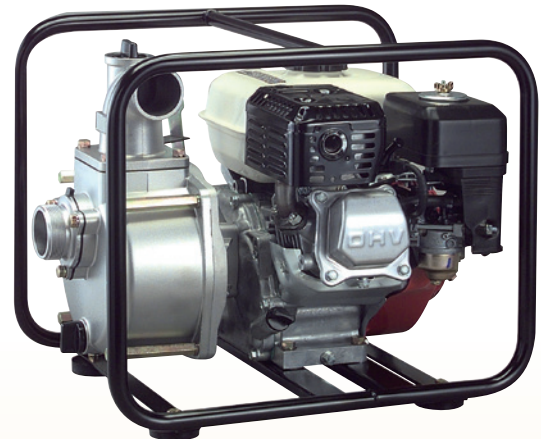

STH-50X

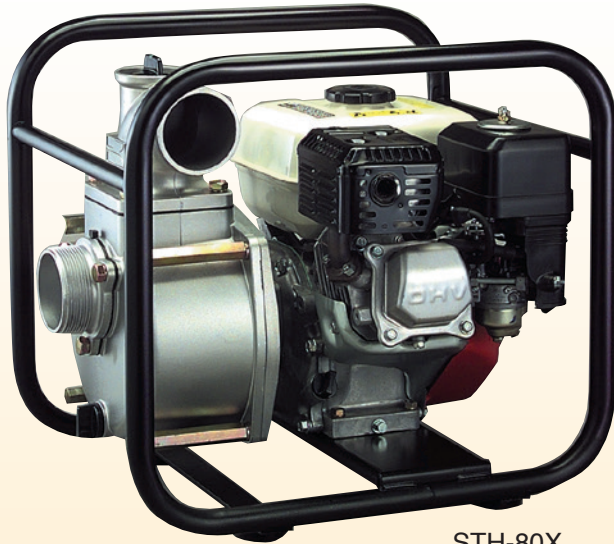

STH-80X

■ Performance Curve

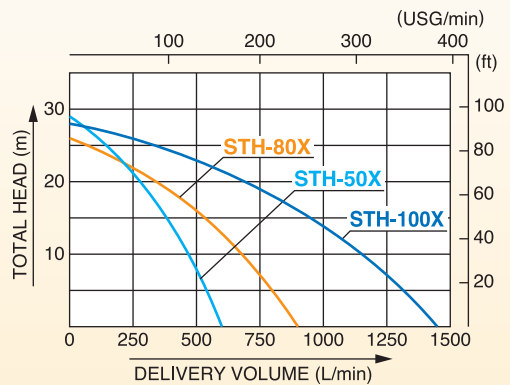

■ Specification

Model		STH-50X	STH-80X	STH-100X
PUMP	Connection Dia	50 mm (2")	80 mm (3")	100 mm (4")
	Connection Thread	Outer Pipe Thread BSP or NPT		
	Total Head	29 m (95 ft)	26 m (85 ft)	28 m (92 ft)
	Delivery Volume	600 L/min (158 USG/min)	900 L/min (238 USG/min)	1450 L/min (383 USG/min)
	Max. Suction Lift	8 m (26 ft)		
ENGINE	Type	Forced Air-cooled 4-stroke Gasoline Engine		
	Model	Honda GX120	Honda GX160	Honda GX240
	Displacement	122 cc	163 cc	270 cc
	Rated Output	2.1 kW (2.9 PS) / 3600 rpm	2.9 kW (3.9 PS) / 3600 rpm	4.6 kW (6.3 PS) / 3600 rpm
	Max. Output	2.4 kW (3.3 PS) / 3600 rpm	3.6 kW (4.9 PS) / 3600 rpm	5.9 kW (8.0 PS) / 3600 rpm
	Fuel	Automotive Unleaded Gasoline		
	Fuel Tank Capacity	2.0 L (0.53 USG)	3.1 L (0.82 USG)	5.3 L (1.40 USG)
	Continuous Operating Time	Approx. 2 hrs		Approx. 2.5 hrs
	Starting Method	Recoil starter		
	Standard Accessories	1 Strainer, 2 Hose Couplings, 3 Hose Bands, 1 Engine Tool Set, 1 Spanner		
Net Weight	23 kg (51 lbs)	29 kg (64 lbs)	56 kg (123 lbs)	
Gross Weight	25 kg (55.1 lbs)	35 kg (77.1 lbs)	64 kg (141 lbs)	
Dimensions L×W×H (mm)	500 × 395 × 415	525 × 389 × 473	680 × 490 × 675	
Packing Unit	1			

Heavy Duty Trash Pumps

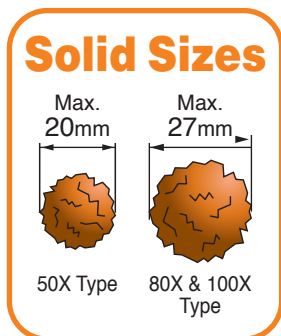

KTH-80X

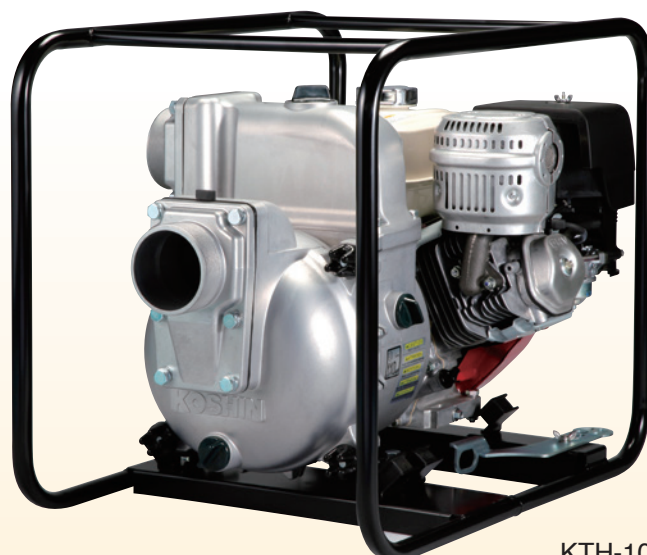

KTH-100X

Performance Curve



Specification

Model	KTH-50X	KTH-80X	KTH-100X	
PUMP	Connection Dia	50 mm (2")	80 mm (3")	100 mm (4")
	Connection Thread	Outer Pipe Thread BSP or NPT		
	Total Head	30 m (98 ft)	27 m (88 ft)	26 m (85 ft)
	Delivery Volume	700 L/min (185 USG/min)	1340 L/min (354 USG/min)	1650 L/min (435 USG/min)
	Max. Suction Lift	8 m (26 ft)		
	Material for Mechanical Seal	SiC (Silicon Carbide) x SiC		
	Material for Impeller	Hi-Chrome		
Material for Volute	Spheroidal Graphite Iron Castings (FCD 450)			
Type	Forced Air-cooled 4-stroke Gasoline Engine			
ENGINE	Model	Honda GX160	Honda GX240	Honda GX340
	Displacement	163 cc	270 cc	389 cc
	Rated Output	2.9 kW (3.9 PS) / 3600 rpm	4.6 kW (6.2 PS) / 3600 rpm	6.3 kW (8.6 PS) / 3600 rpm
	Max. Output	3.6 kW (4.9 PS) / 3600 rpm	5.9 kW (7.9 PS) / 3600 rpm	8.0 kW (10.9 PS) / 3600 rpm
	Fuel	Automotive Unleaded Gasoline		
	Fuel Tank Capacity	3.1 L (0.82 USG)	5.3 L (1.40 USG)	6.1 L (1.61 USG)
	Continuous Operating Time	Approx. 2.2 hrs	Approx. 2.5 hrs	Approx. 2 hrs
	Starting Method	Recoil Starter		
Standard Accessories	1 Strainer, 2 Hose Couplings, 3 Hose Bands, 1 Engine Tool Set			
Net Weight	47 kg (104 lbs)	59 kg (130 lbs)	78 kg (172 lbs)	
Gross Weight	50 kg (110.2 lbs)	62 kg (136.7 lbs)	84.5 kg (186.3 lbs)	
Dimensions LxWxH (mm)	646 x 488 x 509	711 x 506 x 570	780 x 570 x 652	
Packing Unit	1			

New Design for Easy Maintenance

Powered by Honda GX270 & GX390 with oil alert

- The cleanout cover can be removed easily without removing hoses
- Handles on the cleanout cover can be installed in vertical or horizontal position
- Easy removal of knobs
- New Impeller design with hexagon boss for easy installation and removal

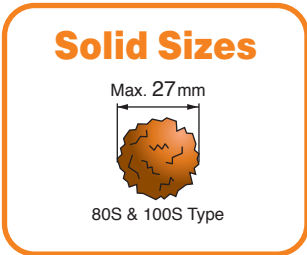

KTH-80S

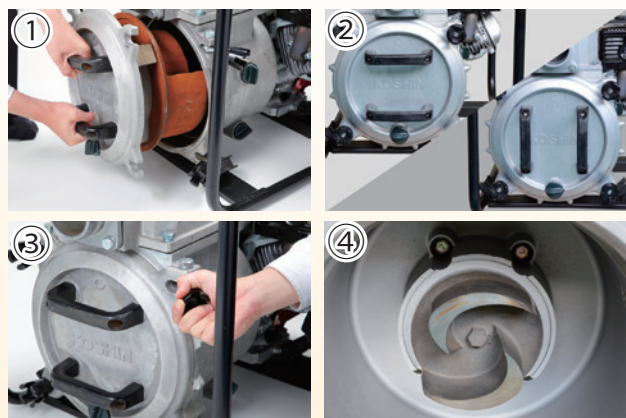

Performance Curve

*Performance ratings are guaranteed minimum, not inflated maximum.



Specification

Model	KTH-80S	KTH-100S	
PUMP	Connection Dia	80 mm (3")	100 mm (4")
	Connection Thread	Outer Pipe Thread BSP or NPT	
	Total Head	27 m (88 ft)	30 m (98 ft)
	Delivery Volume	1450 L/min (383 USG/min)	2050 L/min (542 USG/min)
	Max. Suction Lift	8 m (26 ft)	
	Material for Mechanical Seal	SiC (Silicon Carbide) x SiC	
	Material for Impeller	Hi-Chrome	
	Material for Volute	Spheroidal Graphite Iron Castings (FCD 450)	
	Type	Forced Air-Cooled 4-stroke Gasoline Engine	
	Model	Honda GX270	Honda GX390
ENGINE	Displacement	270 cc	389 cc
	Rated Output	5.1 kW (6.9 PS) / 3600 rpm	7.0 kW (9.5 PS) / 3600 rpm
	Max. Output	6.0 kW (8.2 PS) / 3600 rpm	8.7 kW (11.8 PS) / 3600 rpm
	Fuel	Automotive Unleaded Gasoline	
	Fuel Tank Capacity	5.3 L (1.40 USG)	6.1 L (1.61 USG)
	Continuous Operating Time	Approx. 2 hrs	
	Starting Method	Recoil Starter	
	Accessories	1 Strainer, 2 Hose Couplings, 3 Hose Bands, 1 Engine Tool Set	
	Net Weight	65 kg (143.3 lbs)	79.5 kg (175.3 lbs)
	Gross Weight	71 kg (156.5 lbs)	86.5 kg (190.6 lbs)
Dimensions LxWxH (mm)	730 x 530 x 600	785 x 565 x 630	
Packing Unit	1		



POLYETHYLENE PUMP BODY

For Seawater, Fertilizer

- Superior material used.
 - PET (Polyethylene Terephthalate) for pump casing, impeller and volute casing.
 - EPDM and carbon ceramic for mechanical seal.
 - SUS for all bolts and washers.
- Powered by strong and durable engine.



PGH-50

■ Specification

Model		PGH-50
PUMP	Connection Dia	50 mm (2")
	Connection Thread	Inner Pipe Thread BSP
	Total Head	26 m (85 ft)
	Max. Suction Lift	8 m (26 ft)
	Delivery Volume	560 L/min (148 USG/min)
Material for Mechanical Seal		Ceramic Carbon
ENGINE	Type	Forced Air-cooled 4-stroke Gasoline
	Model	Honda GX120
	Displacement	122 cc
	Rated Output	2.1 kW (2.9 PS) / 3600 rpm
	Max. Output	2.4 kW (3.3 PS) / 3600 rpm
	Fuel	Automotive Unleaded Gasoline
	Fuel Tank Capacity	2.0 L (0.52 USG)
	Continuous Operating Time	Approx. 2 hrs
	Starting Method	Recoil Starter
	Standard Accessories	1 Strainer, 3 Hose Nipples, 1 Elbow 2 Hose Couplings, 3 Hose Bands, 1 Engine Tool Set
Net Weight	23 kg (50.7 lbs)	
Gross Weight	24 kg (52.9 lbs)	
Dimensions LxWxH (mm)	510 × 418 × 418	
Packing Unit	1	

■ Performance Curve

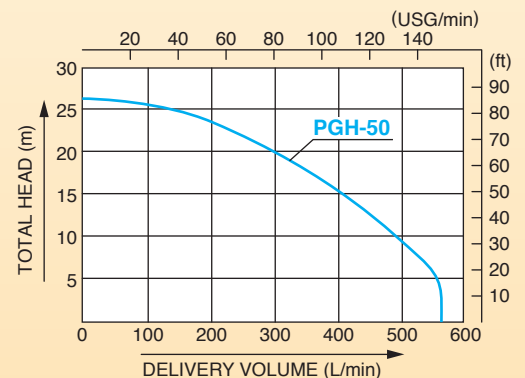



HIGH PRESSURE

Suitable for Sprinkler System & Fire Fighting

New

- Compact & lightweight high pressure pump
- 3 ways discharge flange [2"×1, 1"×2]



SERH-50V SERH-50Z

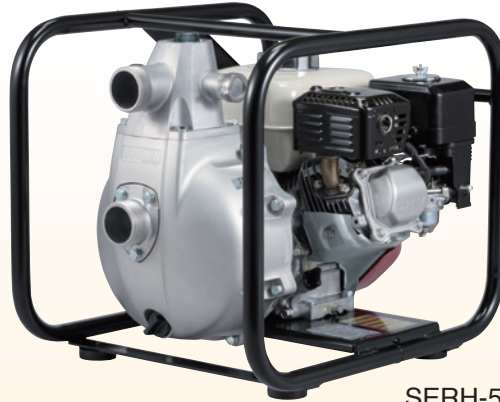

SERH-50V

Specification

Model		SERH-50V	SERH-50Z
PUMP	Connection Dia	50 mm (2")	
	Suction	50 mm (2") / 25 mm (1") × 2	
	Discharge	50 mm (2") / 25 mm (1") × 2	
	Connection Thread	Outer Pipe Thread BSP or NPT*1	
	Total Head	80 m (262 ft)	90 m (295 ft)
ENGINE	Delivery Volume	430 L/min (114 USG/min)	500 L/min (132 USG/min)
	Max. Suction Lift	8 m (26 ft)	
	Type	Forced Air-cooled 4-stroke Gasoline Engine	
	Model	Honda GX160 High rpm	Honda GX200 High rpm
	Displacement	163cc	196cc
	Rated Output	3.2 kW (4.4 PS) / 4300 rpm	3.7 kW (5.0 PS) / 3600 rpm
	Max. Output	3.9 kW (5.3 PS) / 4500 rpm	4.5 kW (6.1 PS) / 4000 rpm
	Fuel	Automotive Unleaded Gasoline	
	Fuel Tank Capacity	3.1L (0.82 USG)	
	Continuous Operating Time	Approx. 2 hrs	
Starting Method	Recoil Starter		
Standard Accessories	1 Strainer φ		
	3 Hose Bands (φ 60)		
	2 Hose Bands (φ 32)		
	1 Coupling Set (50 mm)		
	1 Closing Plate (50 mm)		
2 Nipples (25 mm)			
1 Quick Coupling (25 mm) (*BSP model only)			
1 Engine Tool			
Net Weight	34 kg (75 lbs)	34.6 kg (76 lbs)	
Gross Weight	37 kg (82 lbs)	37.6 kg (83 lbs)	
Dimensions LxWxH (mm)	555 × 450 × 468	570 × 450 × 468	
Packing Unit	1		



SERH-50Z

Performance Curve

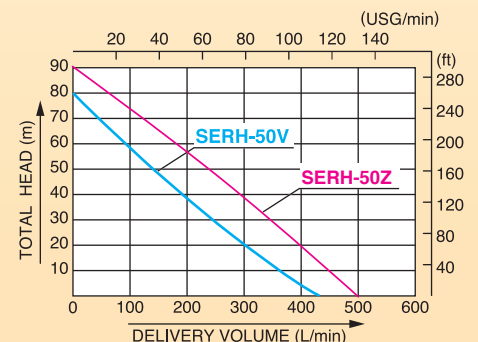

Suitable for Sprinkler (System) & General Irrigation

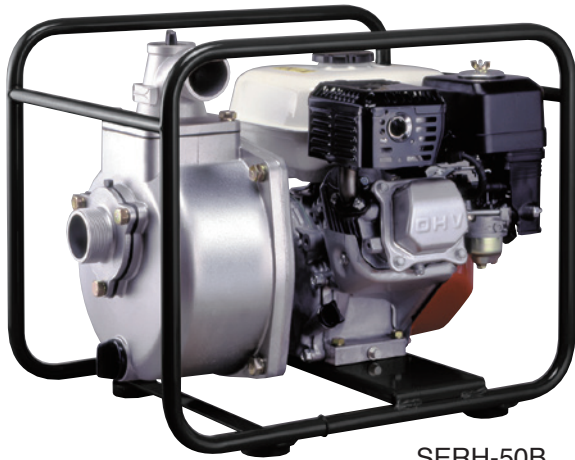

SERH-50B



SERH-50B
SERH-50F



Performance Curve

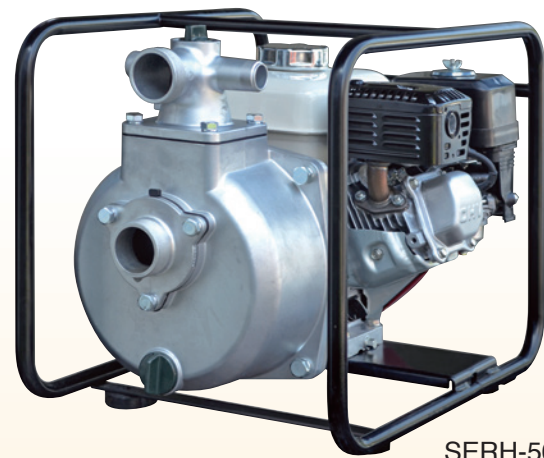
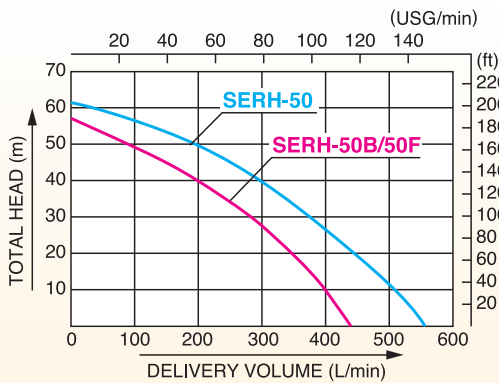

SERH-50F

Specification

Model		SERH-50B	SERH-50	SERH-50F
PUMP	Connection Suction	50 mm (2")	65 mm (2½")	50 mm (2")
	Dia Discharge	50 mm (2")	50 mm (2")	50 mm (2") / 25mm (1") × 2
	Connection Thread	Outer Pipe Thread BSP or NPT		
	Total Head	57 m (187 ft)	62 m (203 ft)	57m (187 ft)
Delivery Volume	440 L/min(116 USG/min)	560 L/min (148 USG/min)	440 L/min (116USG/min)	
Max. Suction Lift	8 m (26 ft)			
Type	Forced Air-cooled 4-stroke Gasoline Engine			
ENGINE	Model	Honda GX160	Honda GX240	Honda GX160
	Displacement	163 cc	270 cc	163cc
	Rated Output	2.9 kW (3.9 PS) / 3600 rpm	4.6 kW (6.3 PS) / 3600 rpm	2.9 kW (3.9 PS) / 3600 rpm
	Max. Output	3.6 kW (4.9 PS) / 3600 rpm	5.9 kW (8.0 PS) / 3600 rpm	3.6 kW (4.9 PS) / 3600 rpm
	Fuel	Automotive Unleaded Gasoline		
	Fuel Tank Capacity	3.1 L (0.82 USG)	5.3 L (1.40 USG)	3.1L (0.82 USG)
	Continuous Operating Time	Approx. 2 hrs	Approx. 2.5 hrs	Approx. 2 hrs
	Starting Method	Recoil Starter		
Standard Accessories	2 Coupling Set 3 Hose Bands (φ 60) 1 Strainer 1 Engine Tool Set	1 Coupling Set (50 mm) 1 Coupling Set (65 mm) 2 Hose Bands (φ 80) 1 Hose Band (φ 60) 1 Strainer (65 mm) 1 Engine Tool Set	1 Coupling Set (50mm) 1 Check Plate (50mm) 2 Check Coupling Set (25mm) 2 Hose Nipple (φ 25) 1 Engine Tool Set	
Net Weight	31 kg (68.3 lbs)	44 kg (97 lbs)	31 kg (68 lbs)	
Gross Weight	34 kg (74.9 lbs)	46 kg (101 lbs)	34 kg (74.9 lbs)	
Dimensions LxWxH (mm)	535 × 405 × 440	568 × 482 × 518	535 × 405 × 455	
Packing Unit	1			

Suitable for Washing & Light Irrigation



Performance Curve

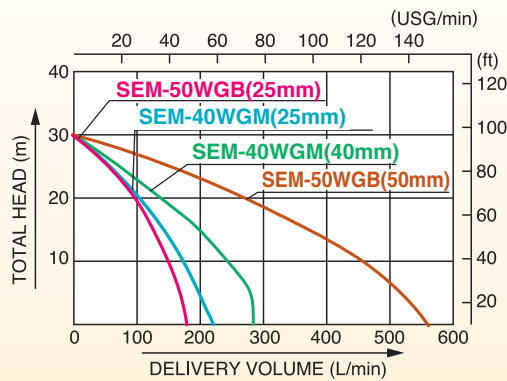
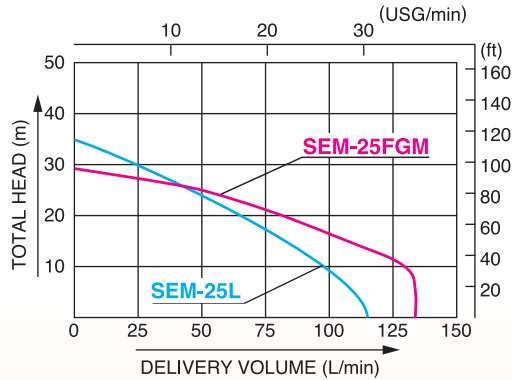

SEM-25L



SEM-25FGM

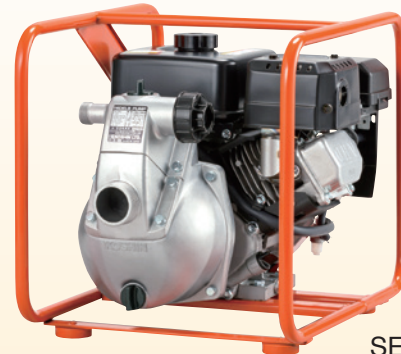

SEM-50WGB

Specification

Model	SEM-25L	SEM-25FGM*	SEM-40WGM*	SEM-50WGB*	
PUMP	Connection Dia	25 mm (1")		Suction:40 mm (1½") Discharge:40 mm (1½")/25 mm (1")	
	Connection Thread	Outer Pipe Thread BSP			
	Total Head	35 m (115 ft)	29 m (95 ft)	30 m (98 ft)	28 m (92 ft)
	Delivery Volume	115 L/min (30 USG/min)	135 L/min (35 USG/min)	40mm:270 L/min (61 USG/min) 25mm:210 L/min (55 USG/min)	50mm:560 L/min (148 USG/min) 25mm:185 L/min (49 USG/min)
	Max. Suction Lift	8 m (26 ft)			
ENGINE	Type	Forced Air-cooled 2-stroke Gasoline Engine			
	Model	Mitsubishi TU26	Mitsubishi GM82	Mitsubishi GB13G	
	Displacement	25.6 cc	79.6 cc	181 cc	
	Rated Output	—	1.3 kW (1.8 PS) / 3600 rpm	3.4 kW (4.7 PS) / 3600 rpm	
	Max. Output	1.03 kW (1.4 PS) / 7500 rpm	1.7 kW (2.4 PS) / 3600 rpm	4.6 kW (6.3 PS) / 4000 rpm	
	Fuel	2 Stroke Mixed Gas and Oil (25:1)	Automotive Unleaded Gasoline		
	Fuel Tank Capacity	0.6 L (0.16 USG)	1.4 L (0.37 USG)	3.4 L (0.89 USG)	
	Continuous Operating Time	Approx. 1 hrs	Approx. 1.5 hrs	Approx. 1.9 hrs	
	Starting Method	Recoil Starter			
Standard Accessories	1 Strainer, 2 Hose Couplings, 3 Hose Bands, 1 Engine Tool Set				
Net Weight	5.0 kg (11.0 lbs)	17.2 kg (37.9 lbs)	20 kg (44.1 lbs)	27 kg (59.5 lbs)	
Gross Weight	6.5 kg (14.3 lbs)	19.2 kg (42.3 lbs)	22 kg (48.5 lbs)	30 kg (66.1 lbs)	
Dimensions LxWxH (mm)	330 x 245 x 325	485 x 325 x 385	495 x 359 x 379	510 x 418 x 446	
Packing Unit	1				

*Japanese Domestic Model

- Highly effective Mechanical Seal made with Special Carbon Ceramics provides extra durability.
- Entire unit is protected by sturdy rollover pipe frame.
- Strong and lightweight die-cast aluminum pump.



SEM-40GB

Performance Curve

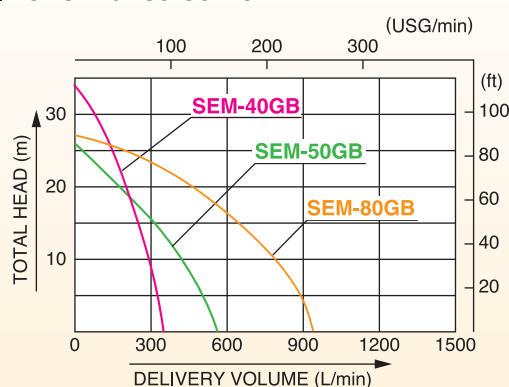

SEM-80GB

Specification

Model		SEM-40GB*	SEM-50GB*	SEM-80GB*
PUMP	Connection Dia	40 mm (1½")	50 mm (2")	80 mm (3")
	Connection Thread	Outer Pipe Thread BSP		
	Total Head	34 m (111 ft)	26 m (85 ft)	27 m (88 ft)
	Delivery Volume	350 L/min (92 USG/min)	560 L/min (148 USG/min)	940 L/min (248 USG/min)
	Max. Suction Lift	8 m (26 ft)		
ENGINE	Type	Forced Air-cooled 4-stroke Gasoline Engine		
	Model	Mitsubishi GB13G		Mitsubishi GB18G
	Displacement	181 cc		
	Rated Output	3.4 kW (4.7 PS) / 3600 rpm		3.4 kW (4.7 PS) / 3600 rpm
	Max. Output	4.6 kW (6.3 PS) / 4000 rpm		
	Fuel	Automotive Unleaded Gasoline		
	Fuel Tank Capacity	3.4 L (0.89 USG)		
	Continuous Operating Time	Approx. 2 hrs		Approx. 1.7 hrs
	Starting Method	Recoil Starter		
	Standard Accessories	1 Strainer, 2 Hose Couplings, 3 Hose Bands, 1 Engine Tools Set		
Net Weight	27.1 kg (59.7 lbs)	25.9 kg (57.1 lbs)	30.9 kg (68.1 lbs)	
Gross Weight	29.1 kg (64.1 lbs)	28.9 kg (63.7 lbs)	35.9 kg (79.1 lbs)	
Dimensions LxWxH (mm)	510 × 418 × 446	510 × 418 × 446	529 × 419 × 492	
Packing Unit	1			

*Japanese Domestic Model

Strong & Durable Robin(CC) Engine

- Highly effective Mechanical Seal made with special Carbon Ceramics provides extra durability.
- Entire unit is protected by sturdy Rollover Pipe Frame.
- Strong and lightweight die-cast Aluminum Pump.



New



SE-80X

Performance Curve

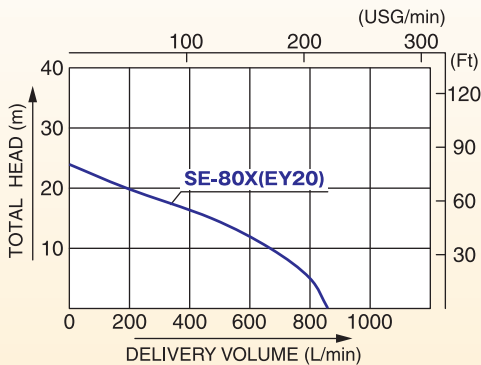

Specification

Model		SE-80X
PUMP	Connection Dia	80mm(3")
	Connection Thread	Outer Pipe Thread BSP
	Total Head	24 m (78 ft)
	Delivery Volume	860 L/min (227 USG/min)
	Max.Suction Lift	8m (26 ft)
ENGINE	Type	Forced Air-Cooled 4-stroke Gasoline Engine
	Model	Robin (CC) EY20
	Displacement	183 cc
	Rated Output	2.6 kW (3.5PS) / 3600 rpm
	Max. Output	3.7 kW (5.0PS) / 4000 rpm
	Fuel	Automotive Unleaded Gasoline
	Fuel Tank Capacity	3.8 L (1.1USG)
	Continuous Operating Time	Approx. 3 hrs
	Starting Method	Recoil Starter
Accessories	1 Strainer, 2 Hose Couplings, 3 Hose Bands, 1 Engine Tool Set	
Net Weight	28 kg (61.7 lbs)	
Gross Weight	30.1 kg (66.4 lbs)	
Dimensions LxWxH (mm)	525 x 370 x 472	
Packing Unit	1	

Yanmar Diesel Clear Water Pumps

- Long operating time with large fuel tank.
- Suitable for mining, shipboard, fire-fighting and construction.



New



SEY-50D



SEY-80D



SEY-100D

Performance Curve

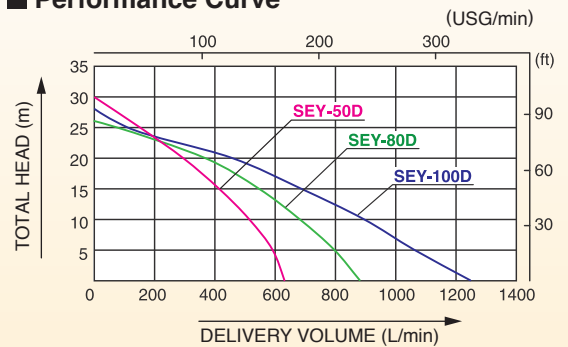

Specification

Model		SEY-50D	SEY-80D	SEY-100D
PUMP	Connection Dia	50mm(2")	80mm(3")	100mm(4")
	Connection Thread	Outer Pipe Thread BSP		
	Total Head	30 m (98 ft)	26 m (85 ft)	28 m (91 ft)
	Delivery Volume	630 L/min (166 USG/min)	880 L/min (232 USG/min)	1250 L/min (330 USG/min)
	Max. Suction Lift	8 m (26 ft)		
ENGINE	Type	Forced Air-Cooled 4-stroke Diesel Engine		
	Model	Yanmar L48N6		Yanmar L70N6
	Displacement	219cc		320cc
	Rated Output	3.1 kW (4.2PS) / 3600 rpm		4.4 kW (6.0PS) / 3600 rpm
	Max. Output	3.5 kW (4.7PS) / 3600 rpm		4.9 kW (6.7PS) / 3600 rpm
	Fuel	Diesel fuel		
	Fuel Tank Capacity	11L (2.9 USG)		
	Continuous Operating Time	Approx. 10.6 hrs		Approx. 7.7 hrs
	Starting Method	Recoil Starter		
	Standard Accessories	1 Strainer, 2 Hose Couplings, 3 Hose Bands, 1 Engine Tool Set		
Net Weight	44.7 kg (98.5 lbs)	46.7 kg (103 lbs)	67 kg (145 lbs)	
Gross Weight	49.3 kg (108.7 lbs)	51.7 kg (114 lbs)	75.8 kg (167 lbs)	
Dimensions L×W×H (mm)	548 × 513 × 698	548 × 513 × 698	668 × 513 × 788	
Packing Unit	1			

For Sandy and Muddy Water

- Long operation time with large fuel tank.
- Suitable for mining and construction site.



- **SIC**
Silicon Carbide Mechanical Seal 4-5 times more durable than Standard Carbon Ceramic mechanical seal.
- **FCD**
Spheroidal Graphite Iron Casting for Impeller & Volute Casing 6.5 times more erosion resistance than Standard FC or Cast Iron.

■ **Outstanding Features**

- Suitable for Sandy and Muddy Water usage
- Particles up to 9 mm can be pumped through
- Guaranteed suction lift of 8 meters
- Long bolt assembly for easy maintenance



STY-100D

Solid Sizes

Max. 8mm Max. 9mm

STY-50D STY-80D
STY-100D



STY-80D

■ **Performance Curve**

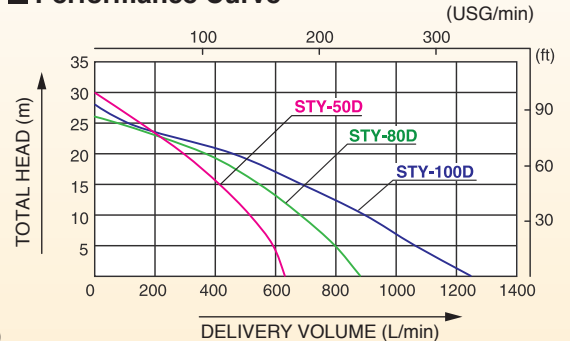

■ **Specification**

	Model	STY-50D	STY-80D	STY-100D
PUMP	Connection Dia	50 mm (2")	80 mm (3")	100mm (4")
	Connection Thread	Outer Pipe Thread BSP		
	Total Head	30 m (98 ft)	26 m (85 ft)	28 m (91 ft)
	Delivery Volume	630 L/min (166 USG/min)	880 L/min (232 USG/min)	1250 L/min (330 USG/min)
	Max. Suction Lift	8 m (26 ft)		
ENGINE	Type	Forced Air-Cooled 4-stroke Diesel Engine		
	Model	Yanmar L48N6		Yanmar L70N6
	Displacement	219 cc		320 cc
	Rated Output	3.1 kW (4.2PS) / 3600 rpm		4.4 kW (6.0PS) / 3600 rpm
	Max. Output	3.5 kW (4.7PS) / 3600 rpm		4.9 kW (6.7PS) / 3600 rpm
	Fuel	Diesel fuel		
	Fuel Tank Capacity	11 L (2.9USG)		
	Continuous Operating Time	Approx. 10.6 hrs		Approx. 7.7 hrs
	Starting Method	Recoil Starter		
	Standard Accessories	1 Strainer, 2 Hose Couplings, 3 Hose Bands, 1 Engine Tool Set		
Net Weight	45.1 kg (99.4 lbs)	47.7 kg (105 lbs)	68.6 kg (151 lbs)	
Gross Weight	50.3 kg (111 lbs)	53.3 kg (118 lbs)	77.5 kg (171 lbs)	
Dimensions LxWxH (mm)	548 x 513 x 698	548 x 513 x 698	668 x 513 x 788	
Packing Unit	1			

Heavy Duty Trash Pumps

- Long operation time with large fuel tank.
- Suitable for mining and construction site.



New

Outstanding Features

- Excellent Seal Durability
- Thoughtful Design
- Light Weight & Compact Design
- High Self-priming Performance



KTY-100D

Solid Sizes

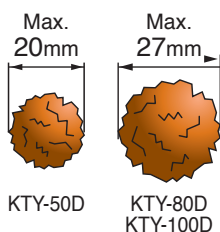

Performance Curve

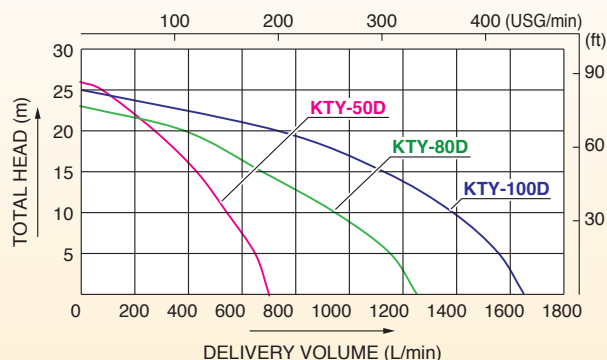

Specification

Model		KTY-50D	KTY-80D	KTY-100D
PUMP	Connection Dia	50mm (2")	80mm (3")	100mm (4")
	Connection Thread	Outer Pipe Thread BSP		
	Total Head	24 m (79 ft)	23 m (75 ft)	27 m (89 ft)
	Delivery Volume	650 L/min (171 USG/min)	1250 L/min (330 USG/min)	1600 L/min (422 USG/min)
	Max. Suction Lift	8 m (26 ft)		
ENGINE	Type	Forced Air-Cooled 4-stroke Diesel Engine		
	Model	Yanmar L48N6	Yanmar L70N6	Yanmar L100N6
	Displacement	219cc	320cc	435cc
	Rated Output	3.1 kW (4.2 PS) / 3600 rpm	4.4 kW (6.0 PS) / 3600 rpm	6.6 kW (9.0PS) / 3600 rpm
	Max. Output	3.5 kW (4.7 PS) / 3600 rpm	4.9 kW (6.7 PS) / 3600 rpm	7.4 kW (10 PS) / 3600 rpm
	Fuel	Diesel fuel		
	Fuel Tank Capacity	Tank size: 13L (3.4USG) / Usage level: 11L (2.9USG)		
	Continuous Operating Time	Approx. 10.6 hrs	Approx. 7.7 hrs	Approx. 5.0 hrs
	Starting Method	Recoil Starter		
	Standard Accessories	1 Strainer, 2 Hose Couplings, 3 Hose Bands, 1 Engine Tool Set		
Net Weight	63.4 kg (139.8 lbs)	82.4 kg (181.7 lbs)	108.5 kg (239.2 lbs)	
Gross Weight	70.1 kg (154.5 lbs)	90.3 kg (199.1 lbs)	118.4 kg (261 lbs)	
Dimensions LxWxH (mm)	708 x 513 x 713	723 x 523 x 768	758 x 548 x 778	
Packing Unit	1			



PABOOL PUMPS

Pabool Pumps are Designed for Sprinkler System & General Irrigation



SU-50H



Performance Curve

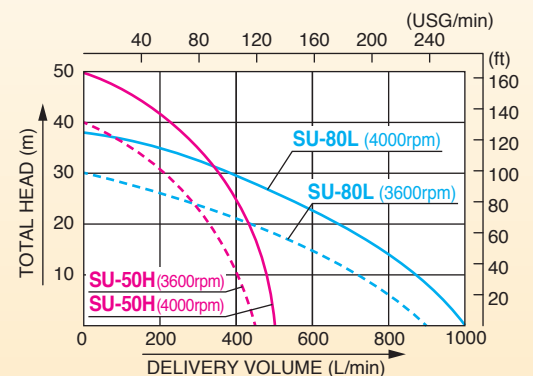
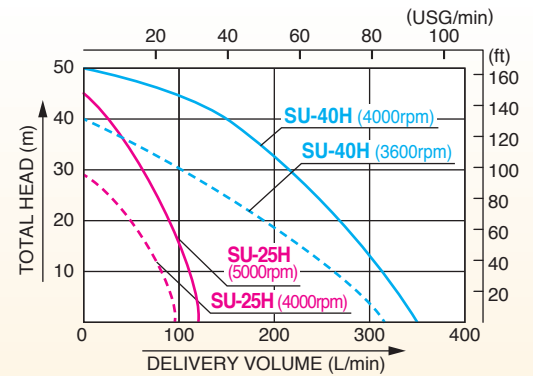

Specification

Model	SU-25H		SU-40H		SU-50H		SU-80L	
Connection Dia	25 mm (1")		40 mm (1½")		50 mm (2")		80 mm (3")	
Connection Thread	Outer Pipe Thread BSP							
Revolution	4000 rpm	5000 rpm	3600 rpm	4000 rpm	3600 rpm	4000 rpm	3600 rpm	4000 rpm
Total Head	29 m (95 ft)	45 m (147 ft)	40 m (131 ft)	50 m (164 ft)	40 m (131 ft)	50 m (164 ft)	30 m (98 ft)	38 m (124 ft)
Max. Suction Lift	8 m (2.6ft)							
Delivery Volume	96 L/min (25 USG/min)	120 L/min (31 USG/min)	315 L/min (83 USG/min)	350 L/min (92 USG/min)	450 L/min (118 USG/min)	500 L/min (132 USG/min)	900 L/min (237 USG/min)	1000 L/min (264 USG/min)
Output	1.5 kW (2 PS)	2.2 kW (3 PS)	2.2 kW (3 PS)	3.7 kW (5 PS)	3.7 kW (5 PS)	5.5 kW (7.5 PS)	5.5 kW (7.5 PS)	7.5 kW (10 PS)
Standard Accessories	1 Strainer, 2 Coupling Sets, 3 Hose Bands							
Net Weight	8.5 kg (19.9 lbs)(1unit)		11 kg (26.5 lbs)(1unit)		14 kg (33.1 lbs)		19.5 kg (19.5 lbs)	
Gross Weight	35 kg (77.1 lbs)(4units)		24 kg (52.9 lbs)(2units)		15 kg (33.0 lbs)		20.5 kg (45.1 lbs)	
Dimensions LxWxH (mm)	615 x 449 x 235		449 x 359 x 259		382 x 250 x 266		414 x 277 x 305	
Packing Unit	4		2				1	

Powerful Pressure & Enhanced Durability

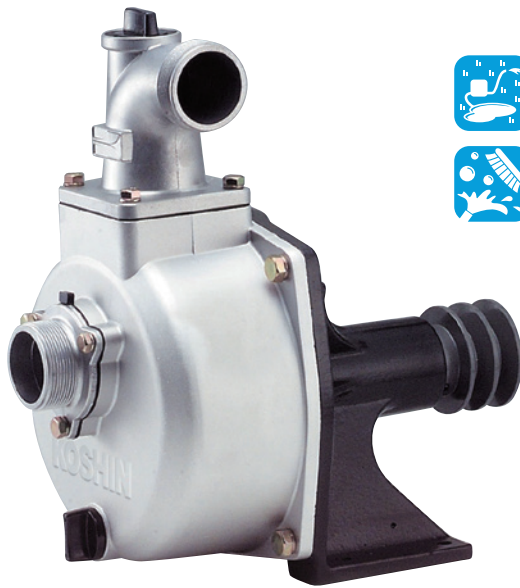

SU-50V



Performance Curve

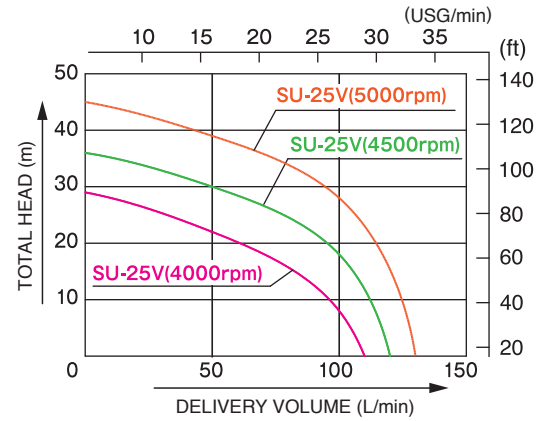

SU-80V

Double Life Span Durability

Standard type → SU-V series

Mechanical Seal

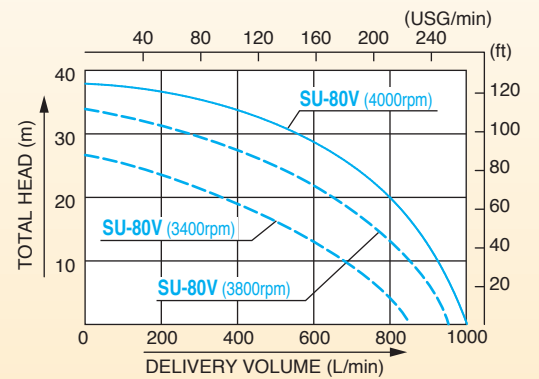
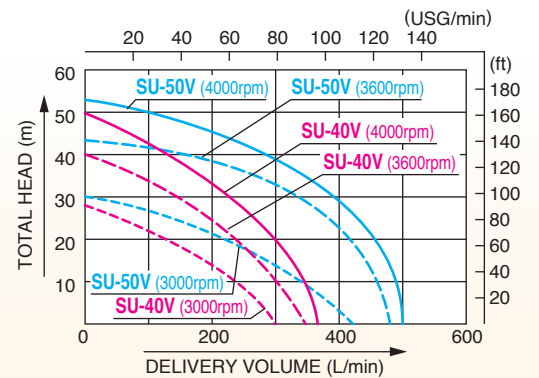

Specification

Model	SU-25V			SU-40V			SU-50V			SU-80V		
Connection Dia	25 mm (1")			40 mm (1½")			50 mm (2")			80 mm (3")		
Connection Thread	Outer Pipe Thread BSP											
Revolution	4000 rpm	4500 rpm	5000 rpm	3000 rpm	3600 rpm	4000 rpm	3000 rpm	3600 rpm	4000 rpm	3400 rpm	3800 rpm	4000 rpm
Total Head	29 m (95 ft)	36 m (118 ft)	45 m (147 ft)	28 m (91 ft)	40 m (131 ft)	50 m (164 ft)	30 m (98 ft)	42 m (137 ft)	53 m (173 ft)	27 m (88 ft)	34 m (111 ft)	38 m (124 ft)
Delivery Volume	110 L/min (29 USG/min)	120 L/min (31 USG/min)	130 L/min (34 USG/min)	300 L/min (79 USG/min)	350 L/min (92 USG/min)	370 L/min (98 USG/min)	430 L/min (113 USG/min)	480 L/min (127 USG/min)	500 L/min (132 USG/min)	850 L/min (224 USG/min)	950 L/min (251 USG/min)	1000 L/min (264 USG/min)
Max. Suction Lift	7 m (23 ft)	8 m (26 ft)	8 m (26 ft)	7 m (23 ft)	8 m (26 ft)		7 m (23 ft)	8 m (26 ft)		7 m (23 ft)	8 m (26 ft)	
Output	1.5 kW (2 PS)	2.2 kW (3 PS)	2.2 kW (3 PS)	1.5 kW (2 PS)	2.2 kW (3 PS)	3.7 kW (5 PS)	2.2 kW (3 PS)	3.7 kW (5 PS)	5.5 kW (7.5 PS)	5.5 kW (7.5 PS)	7.5 kW (10 PS)	8.6 kW (11.5 PS)
Standard Accessories	1 Strainer, 2 Coupling Sets, 3 Hose Bands											
Net Weight	7.5 kg (16.5 lbs)			12.5 kg (27.6 lbs)			15 kg (33.1 lbs)			22 kg (48.4 lbs)		
Gross Weight	8.5 kg (18.7 lbs)			13.5 kg (29.7 lbs)			16 kg (35.3 lbs)			24 kg (52.9 lbs)		
Dimensions LxWxH (mm)	335 × 195 × 210			360 × 212 × 240			392 × 250 × 280			434 × 277 × 378		
Packing Unit	1											



Durable and High Performance Generator

- High Fuel Efficiency
- Ultimate Durability
 - 100% Copper Wire for Alternator
 - Anti-Rusty fuel tank
 - Full roll cage for ultimate protection
- Less Vibration & Quiet Operation

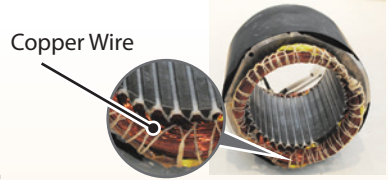

KOSHIN Engine



GV-3000

•All models have oil alert function.





GV-7600S



GV-7600S

■ Specification

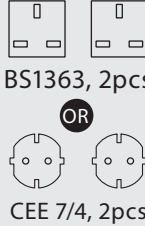
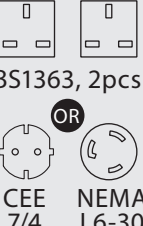
Model		GV-3000	GV-7000S	GV-3200	GV-7600S	
GENERATOR	Phase	Single				
	Voltage Regulation	AVR				
	AC	Rated Output	2 kVA	5 kVA	2.3 kVA	5.5 kVA
		Maximum Output	2.2 kVA	5.5 kVA	2.5 kVA	6 kVA
		Rated Frequency	50 Hz		60 Hz	
		Rated Voltage	220 V			
	DC Output	Rated Ampere	9.1A	22.7 A	10.5 A	25 A
			12 V/8.3 A			
	Continuous Running Time rated load	9.5 h	7.5 h	6.3 h	5 h	
	Tank Capacity	12.6 L	22.6 L	12.6 L	22.6 L	
Receptacle	 European socket, CEE 7/4, 2pcs	 European socket, CEE 7/4, 1pc NEMA L6-30 Socket, 1pc	 BS1363, 2pcs OR CEE 7/4, 2pcs	 BS1363, 2pcs OR CEE 7/4 NEMA L6-30		
ENGINE	Model	Koshin K210	Koshin K420	Koshin K210	Koshin K420	
	Type	Air-cooled, 4-stroke, OHV, single cylinder				
	Displacement	212 cc	420 cc	212 cc	420 cc	
	Oil Alert System	Standard				
	Starting system	Recoil	Recoil/Electric starter	Recoil	Recoil/Electric starter	
	Battery	—	Maintenance-free type	—	Maintenance-free type	
Wheel Kit	—	Standard	—	Standard		
Net Weigh	42 kg (93 lbs)	85 kg (187 lbs)	42.6 kg (94 lbs)	85 kg (187 lbs)		
Gross Weigh	44 kg (97 lbs)	87 kg (192 lbs)	45 kg (99 lbs)	89 kg (196 lbs)		
Dimensions LxWxH (mm)	615 × 445 × 457	695 × 534 × 547	615 × 445 × 457	695 × 534 × 547		
Packing Unit	1					

*GV-7000S/GV-7600S without battery

HEAVY DUTY CONTRACTOR PUMPS

POWERFUL PERFORMANCE! PONSTAR PBX Series

Feature 1 Trouble free operation, even in low water or dry-run situations!
With air valve function

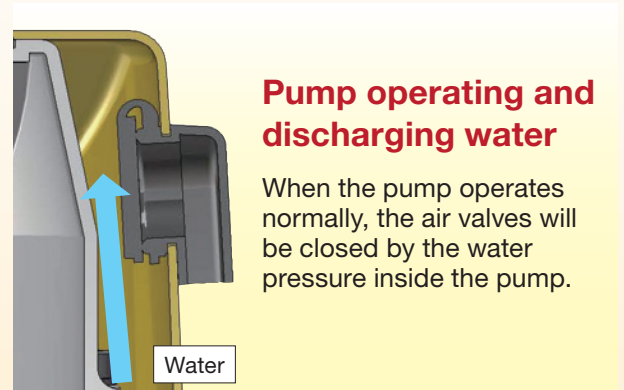
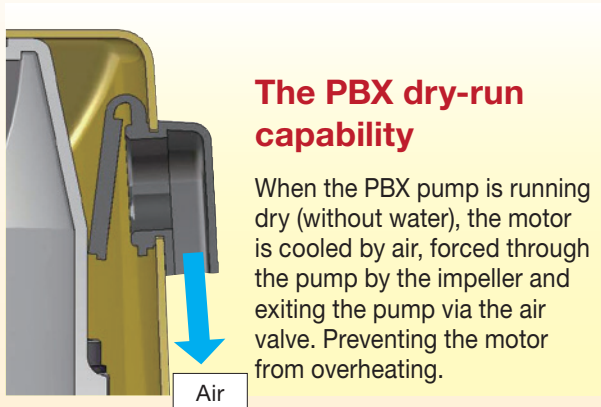

Feature 2 Extra Powerful Startup Torque!
The Koshin centrifugal force switch

Starting torque

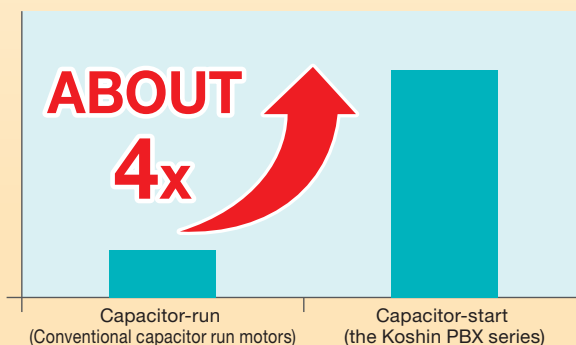

Feature 3 Designed specifically for use in muddy and sandy water, using strong and durable materials



PBX-55022

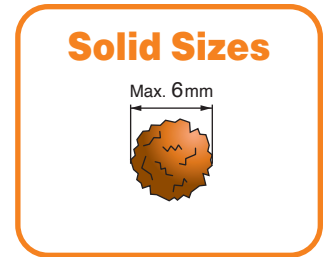

Optional parts

Float switch

When fitted with a (separately available) float switch, the pump can operate fully automatic.



Effective Motor Cooling System

Water is channeled through the outer wall to cool the motor for maximum endurance.

Performance Curve

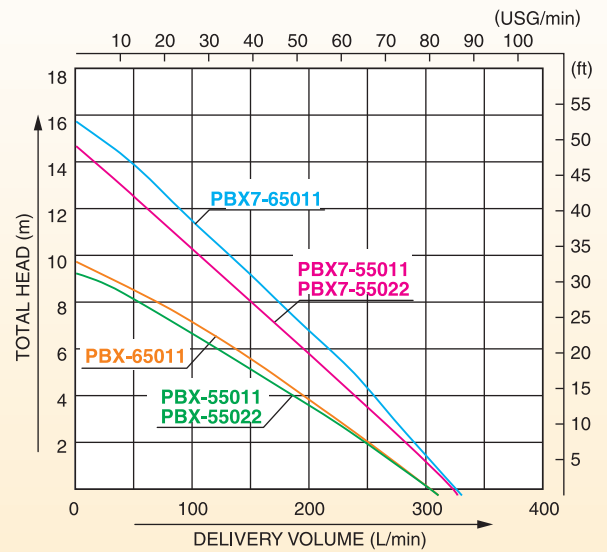

Specification

Model		PBX-55022	PBX-55011	PBX-65011	PBX7-55022	PBX7-55011	PBX7-65011
PUMP	Connection Dia	50 mm (2")					
	Total Head	9.5 m (31 ft)		10 m (32.8 ft)		15 m (50 ft)	
	Delivery Volume	310 L/min (4,870 GPH)			330 L/min (5,240 GPH)		
MOTOR	Voltage	AC 220 V		AC 110 V		AC 220 V	
	Frequency	50 Hz		60 Hz		50 Hz	
	Rated Current	4.2 A	8.1 A	8.7 A		12.0 V	
	Output	400 W			750 W		
	Consumption	680 W	690 W	750 W		1,250 W	
	Revolution	2800 rpm		3200 rpm		3200 rpm	
Type		Condenser Induction Motor					
Power Cord		6 m (19.7 ft) or 10 m (32.8 ft)					
Net Weight		15 kg (33 lbs)	15.5 kg (34 lbs)	15 kg (33 lbs)	15.5 kg (34 lbs)	15.5 kg (34 lbs)	16.5 kg (36 lbs)
Gross Weigh		16 kg (35 lbs)	16.5 kg (36 lbs)	16 kg (35 lbs)	16.5 kg (36 lbs)	16.5 kg (36 lbs)	17.5 kg (37 lbs)
Dimensions LxWxH (mm)		245 x 245 x 450					
Packing Unit		1					

Great Durability

- Pump up to 20mm water level
- Easy maintenance



Solid Sizes



PX-55022

For Residual Water Up to 1 mm water level

- Designed for application in narrow access drainage especially in manhole or bottom pit.



PXL-52522

Applications

- Drainage of underground water
 - Disposal of residual water from roof tank of buildings, swimming pools, etc.
 - Construction site
 - Pond / Aquarium usage
 - Irrigation
 - Home / Domestic application
- *For clear water only

Performance Curve

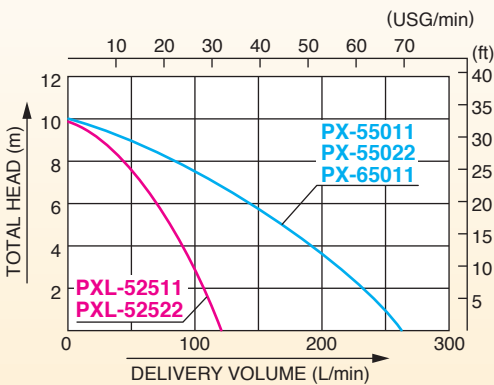

Invertible Delivery Flange

Just 2 bolts delivery flange is inverted



Specification

Model		PX-55011	PX-55022	PX-65011	PXL-52511	PXL-52522	
PUMP	Connection Dia	50 mm (2")			25 mm (1")		
	Total Head	10 m (32.8 ft)					
	Delivery Volume	260 L/min (68 USG/min)			120 L/min (31 USG/min)		
MOTOR	Voltage	AC 110 V	AC 220 V	AC 110 V		AC 220 V	
	Frequency	50 Hz		60 Hz	50 Hz		
	Rated Current*1	6.5 A	3.2 A	6.5 A	6.0 A	2.9 A	
	Output				400 W		
	Consumption	580 W	620 W	700 W	590 W	540 W	
	Revolution	2900 rpm		3400 rpm	2900 rpm		
	Type	Condenser Induction Motor					
	Power Cord	10 m (32.8 ft)	5 m (16.4 ft)	6 m (19.7 ft)	10 m (32.8 ft)		
Standard Accessories	1 Hose Band, 1 Rope (5 m (16.4 ft)), 1 Hose Nipple			1 Rope (5 m (16.4 ft))	1 Hose Band, 1 Hose Nipple, 1 Coupling, 1 Coupling Packing, 1 Rope (5 m (16.4ft))		
Net Weight	11 kg (24.2 lbs) (1 unit)				12.7 kg (28 lbs) (1 unit)		
Gross Weight	25 kg (55.1 lbs) (2 units)				30 kg (66.1 lbs) (2 units)		
Dimensions LxWxH (mm)	490 x 248 x 409	490 x 248 x 409	508 x 259 x 380	505 x 260 x 417			
Packing Unit						2	

*1 Starting current is three times higher than rated current.

Triple Life span Compared with Cast Iron Impeller

• Durable and long life time

Impeller is manufactured from a blended rubber compound providing maximum wear resistance up to three times over cast iron.

Maximal life-span and super hard mechanical seal.

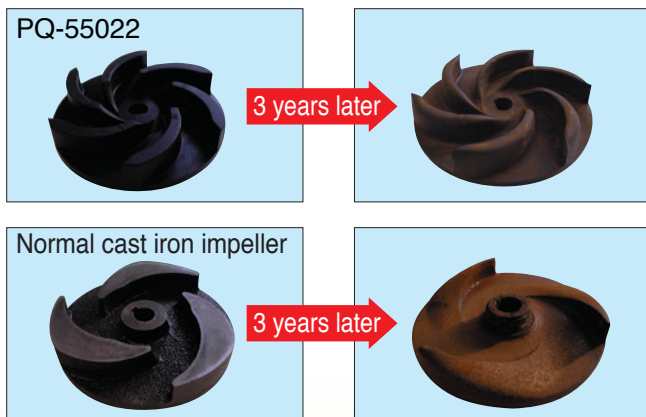

PQ-55022

■ Performance Curve

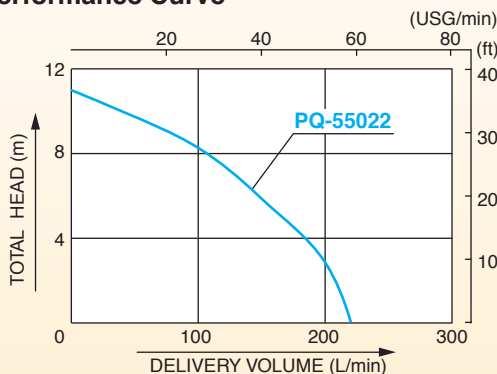

■ Specification

Model		PQ-55022
PUMP	Connection Dia	50 mm (2")
	Total Head	11 m (36.1 ft)
	Delivery Volume	220 L/min (58 USG/min)
MOTOR	Voltage	AC 220 V
	Frequency	50 Hz
	Rated Current	2.7 A
	Output	400 W
	Consumption	550 W
	Revolution	2800 rpm
	Type	Condenser Induction Motor
	Power Cord	5 m (16.4 ft)
Standard Accessories		1 Hose Band, 1 Rope (5 m (16.4 ft))
Net Weight		11.5 kg (24.5 lbs)
Gross Weight		12.5 kg (27.5 lbs)
Dimensions LxWxH (mm)		245 x 205 x 410
Packing Unit		1

"PONDY" & "MARINE PET" Submersible Pump for Seawater

Applications

- Feeding or draining water in fish farms
- Washing purpose
- Draining bilge water



SK-2524



BL-2524N

Performance Curve

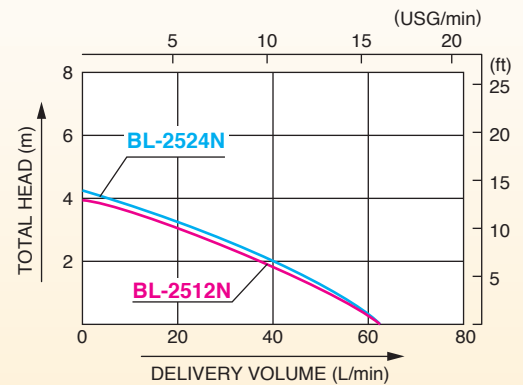
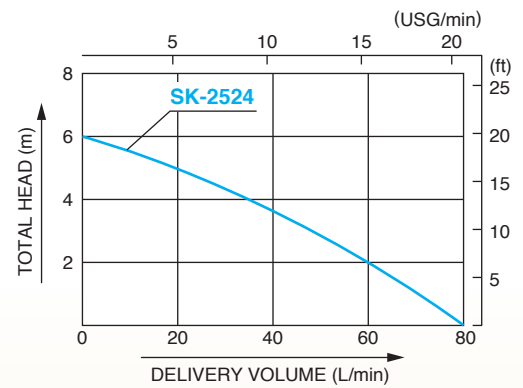

Specification

Model		SK-2524	BL-2512N	BL-2524N
PUMP	Connection Dia		25 mm (1")	
	Total Head	6 m (19.6 ft)	4 m (13.1 ft)	4.2 m (13.8 ft)
	Delivery Volume	80 L/min (21 USG/min)	63 L/min (16 USG/min)	
MOTOR	Voltage	DC 24 V	DC 12 V	DC 24 V
	Frequency	—		
	Rated Current	8.5 A	7.8 A	3.8 A
	Rating	Continuous		
	Output	123 W	50 W	
	Revolution	3000 rpm	5800 rpm	
	Life Span	Approx. 500 hrs	Approx. 500 hrs	
	Power Cord	5 m (16.4 ft)	2.95 m (9.7 ft)	
Standard Accessories		1 Coupling Set (φ25) 1 Hose Nipple (φ20) 1 Hose Band (φ25) 1 Hose Band (φ20) 1 Rope (5 m (16.4 ft))	1 Elbow	
Net Weight		5.5 kg (12.2 lbs) (1 unit)	1.3 kg (2.2 lbs) (1 unit)	
Gross Weight		11 kg (24.2 lbs) (2 units)	32 kg (70.5 lbs) (20 units)	
Dimensions L×W×H (mm)		415 × 238 × 300	564 × 273 × 408	
Packing Unit		2	20	



HIGH PRESSURE WASHER

High Pressure Washer Powered by Koshin Engine

- **1.5M Self Priming Guarantee (vertically 1.5M)**
Self priming pump system capable of pumping up water from any water source
- **Powered by Reliable Koshin Engine**
Koshin K180 and K210 engine for quiet, reliable performance
- **Quick Couple Nozzle Set as Standard Accessory**

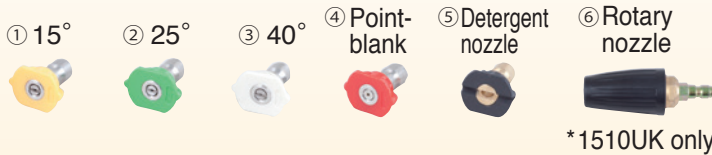

**5.6 HP
MAX 2180 PSI**

JCE-1510UK

■ Specification

Model	JCE-1408U	JCE-1408UDX	JCE-1510UK	
PUMP	Max. Pressure	14 MPa		
	Max. Volume	8 L/min		
	Recommended Feed-water	Clear water at 5 – 40 °C		
	Max. Suction Lift	1.5 m		
	Necessary Volume of Engine Oil	120 cc	450 cc	
ENGINE	Type	Forced Air-Cooled 4-stroke OHV Gasoline Engine		
	Model	Koshin K180		
	Displacement	179 cc	212 cc	
	Fuel	Automotive Unleaded Gasoline		
	Fuel Tank Capacity	3.6 L		
	Engine Oil	SAE 10W-30		
	Necessary Volume of Engine Oil	600 cc		
	Accessories	1 Gun Nozzle (screw attachment type), 1 Straight/Fan shape nozzle, 1 Delivery hose (screw attachment type) (10 m), 2 Suction hoses (3m), 1 Strainer	1 Gun Nozzle (quick attachment type), 1 Delivery hose (quick attachment type) (10 m), 2 Suction hose (3m), 1 Strainer 5 Interchangeable nozzle: (1) 15° (2) 25° (3) 40° (4) point-blank (5) Detergent nozzle	1 Gun Nozzle (quick attachment type), 1 Delivery hose (quick attachment type) (10 m), 1 Strainer, 2 Suction hoses (3 m) 6 Interchangeable nozzle: (1) 15° (2) 25° (3) 40° (4) point-blank (5) Detergent nozzle (6) Rotary nozzle
Net Weight	25 kg (55 lbs)	32.5 kg (72 lbs)	36 kg (79 lbs)	
Gross Weight	34.5 kg (76.0 lbs)	42.5 kg (93.7 lbs)	46.0 kg (101 lbs)	
Dimensions LxWxH (mm)	540 × 435 × 525	710 × 400 × 530	710 × 400 × 530	
Packing Unit	1			

FOR INDUSTRIAL APPLICATION

"GEAR PUMP" GL Series for Low Viscosity Oil

- Safety by-pass function protects pump.
- For oil transfer

Applications

- Kerosene
- Machine oil
- Heavy oil
- Light oil



GL-25-5

Performance Curve

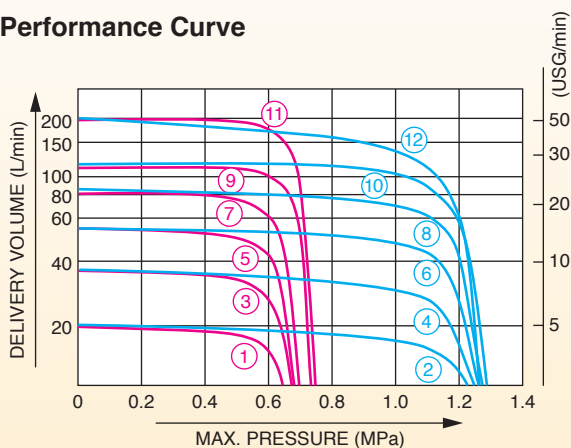

* Gasoline must not be used.

Specification

Model		GL-13-5	GL-13-10	GL-20-5	GL-20-10	GL-25-5	GL-25-10	GL-32-5	GL-32-10	GL-40-5	GL-40-10	GL-50-5	GL-50-10						
Performance Curve No.		①	②	③	④	⑤	⑥	⑦	⑧	⑨	⑩	⑪	⑫						
Connection Dia		13 mm (½")		20 mm (¾")		25 mm (1")		32 mm (1¼")		40 mm (1½")		50 mm (2")							
Power		0.4 kW	0.75 kW	0.75 kW	1.5 kW	1.5 kW	2.2 kW	2.2 kW	3.7 kW	2.2 kW	5.5 kW	3.7 kW	7.5 kW						
Poles		4 P																	
PUMP	Max. Pressure	MPa	0.5	1	0.5	1	0.5	1	0.5	1	0.5	1	0.5	1					
		kgf/cm ²	5	10	5	10	5	10	5	10	5	10	5	10					
	Delivery Volume	60 Hz (1800 rpm)	20 L/min (5 USG/min)		35 L/min (9 USG/min)		55 L/min (14 USG/min)		80 L/min (21 USG/min)		60 Hz (1200 rpm)	123 L/min (32 USG/min)		200 L/min (52 USG/min)					
	50 Hz (1500 rpm)	17 L/min (4 USG/min)		29 L/min (7 USG/min)		46 L/min (12 USG/min)		66 L/min (17 USG/min)		50 Hz (1000 rpm)	100 L/min (26 USG/min)		165 L/min (43 USG/min)						
Material of Housing		ADC																	
Coupling		ZDC						JIS											
Pump Shaft Dia		φ 18 mm																	
Net Weight		4.4 kg (10 lbs)		4.6 kg (10 lbs)		5 kg (11 lbs)		8 kg (16 lbs)		8.5 kg (19 lbs)		22.5 kg (50 lbs)		24 kg (53 lbs)		26 kg (57 lbs)		28.5 kg (63 lbs)	
Gross Weight		4.8 kg (11 lbs)		5.0 kg (11 lbs)		5.6 kg (13 lbs)		8.5 kg (19 lbs)		9 kg (20 lbs)		23.5 kg (52 lbs)		25 kg (55 lbs)		27 kg (60 lbs)		29.5 kg (65 lbs)	
Dimensions LxWxH (mm)		224 × 150 × 155			224 × 150 × 155			224 × 150 × 155		307 × 150 × 155		307 × 150 × 155		318 × 258 × 220		318 × 258 × 220		318 × 258 × 220	
Packing Unit		1																	

"GEAR PUMPS"

Suitable for Water, Oil & Various Liquids Applications



GB-13
GC-13



GB-25
GC-25

Applications (GB)

- Water
- Sea water
- Weak acids
- Various chemicals
- Coal tar



Applications (GC)

- Kerosene
- Light oil
- Machine oil
- Heavy oil
- Water



Performance Curve

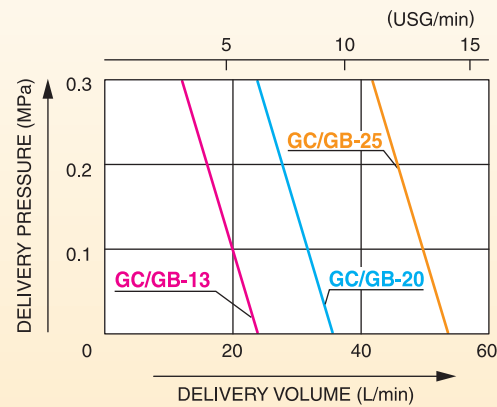

Specification

Model	GC-13	GB-13	GC-20	GB-20	GC-25	GB-25
Gear Material	GC: Cast Iron / GB: Brass					
Connection Dia	13 mm (1/2")		20 mm (3/4")		25 mm (1")	
Delivery Volume (400 rpm)	21 L/min (5 USG/min)		37 L/min(9 USG/min)		55 L/min (14 USG/min)	
Delivery Pressure	0 - 0.3 MPa (0 - 3 kg/cm ²)					
Max. Suction Lift	Max. 4 m (13.1 ft)					
Power	200 W		400 W		750 W	
Pulley	5" (125mm) x A1		6" (150mm) x A1		8" (200mm) x A1	
Net Weight	4 kg (8.8 lbs) (1 unit)		6 kg (13.2 lbs) (1 unit)		11 kg (24.3 lbs) (1 unit)	
Gross Weight	17.5 kg (38.6 lbs) (4 units)		25 kg (55.1 lbs) (4 units)		22.5 kg (49.6 lbs) (2 units)	
Dimensions LxWxH (mm)	391 x 236 x 167		482 x 252 x 179		402 x 267 x 250	
Packing Unit			4		2	

"CHANGE MASTER" Oil Change Pumps

- Powerful pump transfers high viscosity oil. (Up to 800 cst)
- Highly recommended for motor oil change.
- Safety by-pass valve protects pump.

Applications

- Motor oil
- Machine oil
- Heavy oil
- Light oil



*Gasoline must not be used.

Specification

Model		GM-2524H
PUMP	Dia of Hose Inlet	25 mm (1")
	Dia of Hose Outlet	20 mm (¾")
	Connection Thread	Inner Pipe Thread
	Max. Delivery Pressure	0.2 MPa (2 kgf/cm ²)
	Delivery Volume	20 L/min (5 USG/min)
	Applicable Viscosity	800 cst
	Voltage	DC 24 V
MOTOR	Rated Current	16 A
	Output	200 W
	Revolution	6200 rpm
	Rating	25 min
	Power Cord	5 m (16 ft)
Net Weight	8.5 kg (19 lbs)	
Gross Weight	9.2 kg (21 lbs)	
Dimensions LxWxH (mm)	310 × 178 × 253	
Packing Unit	1	



E-type Hose Set for GM Pumps

- Suction Dia: 25 mm (1") × 2 m (6.5 ft)
- Discharge Dia: 20 mm (¾") × 2 m (6.5 ft)
- 1 Nozzle, 1 Strainer, 2 Joints



Performance Curve

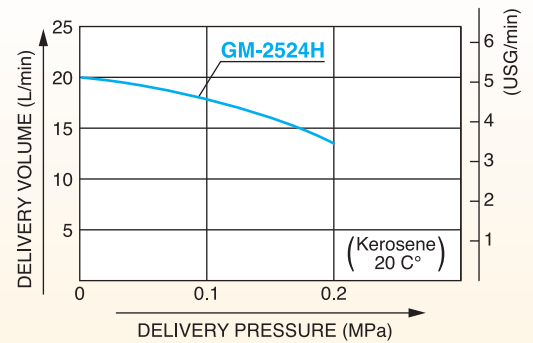

"FS PUMP" Self-priming Pump for Low Viscosity Oil

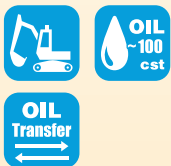

* Gasoline must not be used.

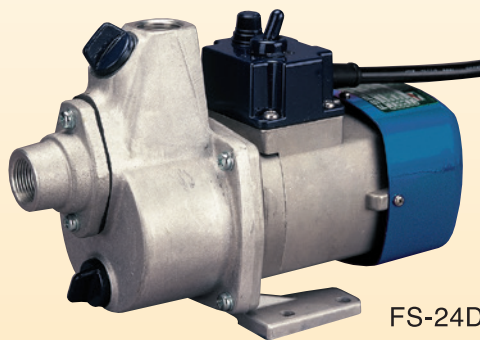

Specification

Model	FS-12D	FS-24D
Connection Dia	20 mm (¾")	
Total Head	7 m (23 ft)	9 m (30 ft)
Delivery Volume	40 L/min (10 USG/min)	50 L/min (13 USG/min)
Max. Suction Lift	3 m (9.8 ft)	
Voltage	DC 12 V	DC 24 V
Rated Current	15 A	8 A
Output	80 W	90 W
Revolution	7300 rpm	
Net Weight	4.5 kg (10 lbs) (1 unit)	
Gross Weight	25 kg (55 lbs) (5 units)	
Dimensions LxWxH (mm)	780 × 305 × 227	
Packing Unit	5	

T-type Hose Set for FS Pumps

- Suction Dia: 20 mm (¾") × 2 m (6.5 ft)
- Discharge Dia: 20 mm (¾") × 2 m (6.5 ft)
- 1 Nozzle, 1 Strainer, 2 Joints



Performance Curve

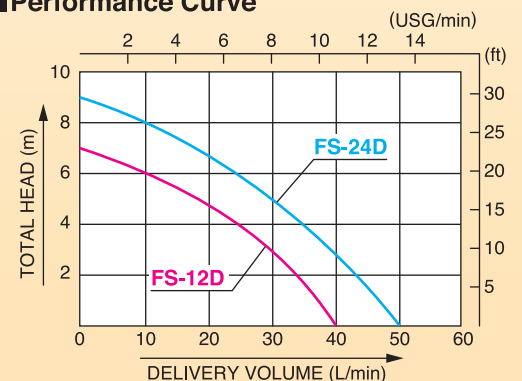

Powerful "FILL PUMP" Only 2 Minutes to Empty 200 L Drum (FR-200)

- Two stage system of axial flow vane and spiral vane result in an excellent flow rate.

Applications

- Low viscosity oil
- Heavy fuel oil A
- Kerosene
- Diesel
- Light oil



FD-12



FA-100



FR-200

Performance Curve

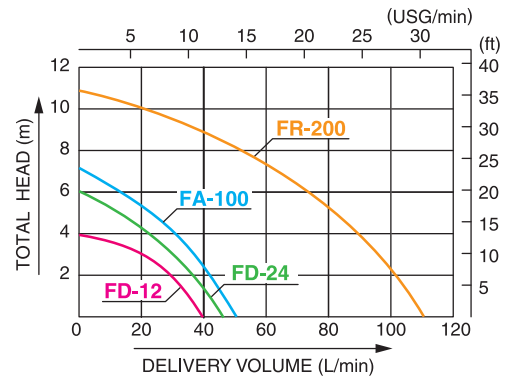

* These pumps are not designed for use with liquids with low flash-point, such as gasoline, etc.

Specification

Model		FD-12	FD-24	FA-100	FR-200
PUMP	Connection Dia	20 mm (3/4")			32 mm (1 1/4")
	Connection Thread	Inner Pipe Thread			
	Total Head	4 m (13 ft)	6 m (19 ft)	7 m (23 ft)	11 m (36 ft)
	Delivery Volume	40 L/min (10 USG/min)	45 L/min (12 USG/min)	50 L/min (13 USG/min)	110 L/min (29 USG/min)
MOTOR	Type	Enclosed Fan-Cooled Commutator			
	Voltage	DC 12 V	DC 24 V	AC 110 V / 130 V	AC 220 V - 240 V
	Rated Current	14 A	7 A	2.7 A	1 A
	Output	80 W	90 W	120 W	200 W
	Revolution	6000 rpm	6700 rpm	7350 rpm	6200 rpm
	Rating	Continuous			
	Power cord	Oil-Proof Cord 5 m			
Suction Pipe	920mm			922mm	
Delivery Hose	1 Oil-Proof Rubber Hose (φ20 mm (φ3/4") × 2 m)			1 Oil-Proof Rubber Hose (φ32 mm (φ1 1/4") × 2 m)	
Net Weight	8 kg (17.6 lbs) (1 unit)			12.5 kg (27.6 lbs) (1 unit)	
Gross Weight	20 kg (44.1 lbs) (2 units)			30 kg (66.1 lbs) (2 units)	
Dimensions LxWxH (mm)	1218 × 281 × 157			1218 × 281 × 157	
Packing Unit	2				

Suitable for Transferring Kerosene & Diesel

- 10 minutes to empty 200 L drum.
- Easy to use gun nozzle.
- Suction pipe with mesh strainer.

■ Applications

- Kerosene
- Diesel



* Gasoline must not be used.

■ Specification

Model	FP-25	FP-2512	SFP-2518*3
Connection Dia	25 mm (1")		
Total Head	3.5 m (11 ft)	2.8 m (9 ft)	3.5m (11 ft)
Delivery Volume	20 L/min (5.3 USG/min)	18 L/min (4.7 USG/min)	20 L/min (5.3 USG/min)
Voltage	AC 100 V AC 220 V	DC 12 V	DC-18V 2.0Ah (Li-ion)
Frequency	50 Hz / 60 Hz		
Charging time *1	—		Approx. 70 min
Operating time *2	—		Approx. 90 min
Power Code	4 m (13 ft)		—
Suction Pipe	950 mm		
Delivery Hose	φ25 mm × 1.5 m		
Net Weight	2.7 kg (6.1 lbs)	2 kg (2.2 lbs)	1.8kg (3.9lbs)
Gross Weight	3.8 kg (8.3 lbs)	3.1 kg (6.8 lbs)	3.4kg (7.4lbs)
Dimensions LxWxH (mm)	1180 × 225 × 115		1155 × 220 × 120
Packing Unit	1		

*1 May differ depending on temperature or remaining battery power. *2 At full charge, no load. *3 Japanese Domestic Model.



FP-25

For High Viscosity Oil (Up to 2000 cst)

- Specially designed for dispensing oil at service stations.

■ Applications

- High viscosity oil



SO-25

■ Specification

Model	SO-25
Delivery Volume	0.5 L/Stroke (0.1 USG/Stroke)
Suction Pipe	1038 mm
Net Weight	5.1 kg (11.2 lbs) (1 unit)
Gross Weight	35 kg (77 lbs) (5 units)
Dimensions LxWxH (mm)	1420 × 300 × 165
Packing Unit	5

"HIGH LITER PUMP" High Volume

- Delivers 1 L per rotation.
- Mesh strainer can filter fine dust.
- Applicable for low viscosity oil.

■ Applications

- Diesel
- Kerosene
- Heavy fuel oil A



*Oil temperature is over 10°C



LP-32

■ Specification

Model	LP-32
Delivery Volume	1 L / 1 Rotation, (Normal Use) 100 L/min (26 USG/min)
Suction Pipe	φ 32 × 956 mm
Delivery Hose	φ32 × 1280 mm
Strainer	#60 with Mesh, Polyethylene
Net Weight	8 kg (17.6 lbs) (1 unit)
Gross Weight	33.5 kg (73.8 lbs) (5 units)
Dimensions LxWxH (mm)	1127 × 242 × 280
Packing Unit	5

"HAND ROTARY PUMP"

Compact in Design & Light Weight

• Applicable for low viscosity.

Applications

- Heavy fuel oil A
- Kerosene
- Diesel



★Oil temperature is over 10°C

Specification

Model	SB-20	SB-25
Delivery Volume	20 L (5 USG) / 105 Rotations	20 L (5 USG) / 72 Rotations
Impeller Material	PPS	
Suction Pipe	1001 mm	1038 mm
Delivery Hose	φ 20 × 1100	φ 25 × 1280
Net Weight	3.8 kg (8.4 lbs) (1 unit)	5.8 kg (12.8 lbs) (1 unit)
Gross Weight	24 kg (52.9 lbs) (6 units)	25 kg (55.1 lbs) (4 units)
Dimensions LxWxH (mm)	1050 × 235 × 130	1075 × 192 × 205
Packing Unit	6	4



SB-25

"BIG AUTO PUMP"

Light weight & Economical to Use

• Made of strong plastics.

Applications (PP-25)

- Dispensing small volumes of liquid
- Heavy fuel oil A
- Kerosene
- Diesel
- Water
- Wine

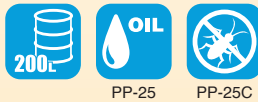

PP-25

PP-25C

(PP-25C)

- Solvent



PP-25

PP-25C

Specification

Model	PP-25	PP-25C
Delivery Volume	20 L/min (5 USG/min)	
Material	Polyethylene	
Pump Length	1190 mm	
Suction Pipe	878 mm	
Delivery Hose	φ 25 × 1162 mm	
Net Weight	0.4 kg (0.9 lbs) (1 unit)	
Gross Weight	11 kg (24.2 lbs) (20 units)	
Dimensions LxWxH (mm)	1225 × 450 × 255	
Packing Unit	20	

PP-25C Chemical Compatibility Rating Information

Rating Scale	
○	No Effect
△	Moderate Effect
×	Not Recommended
N	Information Not Available

Chemical (100% concentration unless noted)	Rating
A Acetone	×
Ammonium Hydroxide	N
C Chlorine	○
D Deionized Water	△
Diesel Fuel	○
E Ethanol	○
G Gasoline	△
Glycol	N
H Hydrochloric Acid (20%)	○
Hydrochloric Acid (37%)	○
Hydrochloric Acid (100%)	○
I Isopropyl Alcohol	N
K Kerosene	○
L Lacquer Thinner	×
M Methanol	○
Methyl Chloride	×
Methyl Ethyl Ketone	×
Mineral Spirits	N
Motor Oil	○
N Nitric Acid (20%)	△
Nitric Acid (50%)	△
Nitric Acid (Concentrated)	△
O Oil, Hydraulic	○
P Paint	×
Phosphoric Acid (< 40%)	○
Phosphoric Acid (≥ 40%)	○
S Salt Water	○
Seawater	○
Sodium Hypochlorite	N
Sodium Hydroxide (20%)	N
Sodium Hydroxide (50%)	N
Sodium Hydroxide (80%)	N
Sulfuric Acid (<10%)	○
Sulfuric Acid (10-75%)	○
Sulfuric Acid (75-100%)	○
W Water	○
X Xylene	△

"PACO-PET" Plastic Syphon Pumps

■ Applications

- Kerosene
- Gasoline
- Diesel oil
- Solvent
- Water (Non-potable)

■ Specification

Model	PH-10	PH-20
Delivery Volume	6.7 L/min (1 USG/min)	11.5 L/min (3 USG/min)
Pump Length	517 mm (20")	613 mm (24")
Suction Pipe	385 mm	410mm
Delivery Hose	545 mm	572 mm
Gross Weight	11.5 kg (25 lbs) (120 units)	10.5 kg (23 lbs) (60 units)
Dimensions LxWxH (mm)	685 × 355 × 608	800 × 345 × 495
Packing Unit	120	60

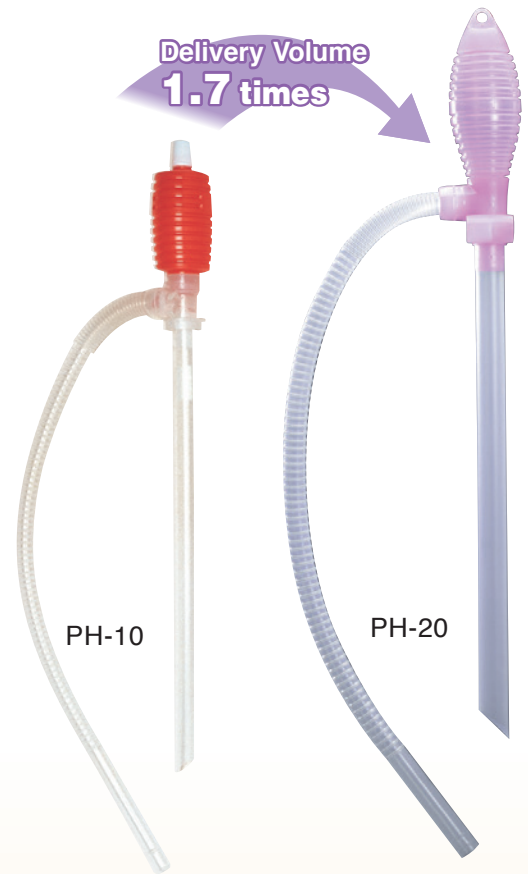

"MAMA AUTO" Plastic Pumps Operated by Dry Cell Battery

■ Applications

- Kerosene

No
Overflow
Trouble

(EP-305,
EP-305BC,
EP-305L)

Type AA

2 Batteries
(Not Included)

Big Switch
for Easy
ON/OFF
Control

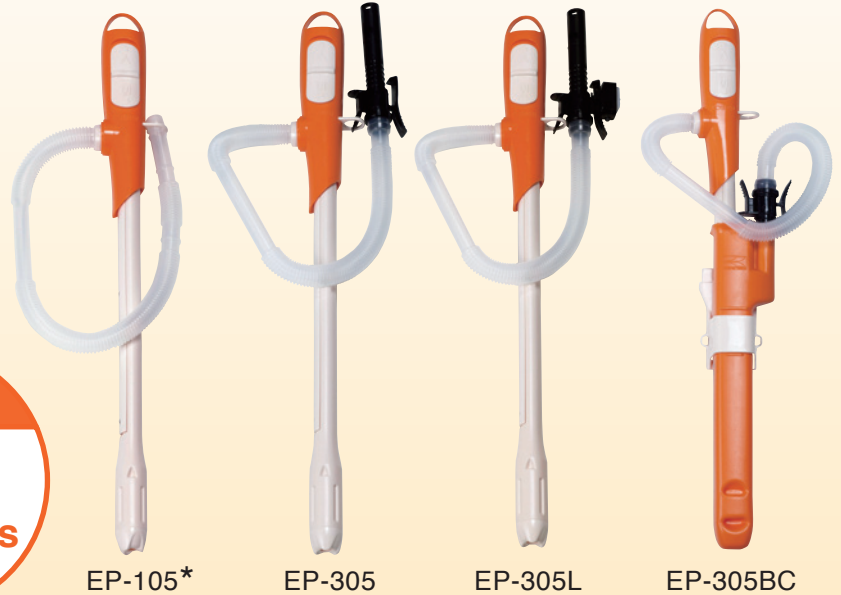

■ Specification

Model	EP-105	EP-305	EP-305L	EP-305BC
Delivery Volume	12 L/min (3 USG/min)			
Pump Length	547 mm (21")			
Suction Pipe	343 mm			
Delivery Hose	590 mm			
Stop Sensor	—	○	○	○
Accessories	—	—	Night Light	Case
Case Length	—	—	—	333 mm (13")
Power	2 × 1.5 V AA Batteries (Not Included)			
Gross Weight	5.4 kg (12 lbs) (20 units)	5.9 kg (13 lbs)(20 units)	6.2 kg (14 lbs)(20 units)	5.1 kg (11 lbs)(12 units)
Dimensions LxWxH (mm)	305 × 315 × 585			290 × 280 × 615
Packing Unit	20			12

*EP-105 does not have auto stop function.

GEAR PUMP

GL—

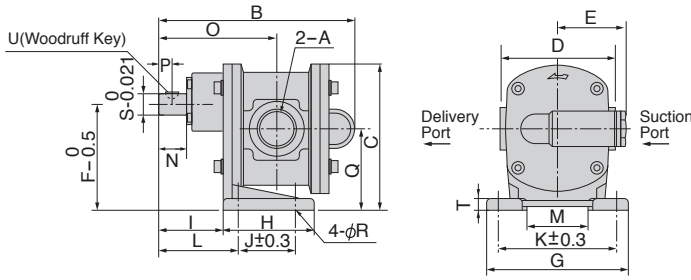

Type	A	B	C	D	E	F	G	H	I	J	K	L	M
GL-13-□	G $\frac{1}{2}$ "	189	131	108	64.5	95	138	73	71	40	116	87	58
GL-20-□	G $\frac{3}{4}$ "	196	131	108	64.5	95	138	73	71	40	116	87	58
GL-25-□	G1"	208	131	108	64.5	95	138	73	71	40	116	87	58
GL-32-□	G $\frac{1}{4}$ "	222	131	108	64.5	95	138	73	71	40	116	87	58
GL-40-□	G $\frac{1}{2}$ "	265	189	148	89.5	136	184	112	86	70	156	111	100
GL-50-□	G2"	290	189	148	89.5	136	184	112	86	70	156	111	100

N	O	P	Q	R	S	T	U
30	113	15	75	11	18	12	4x19
30	117	15	75	11	18	12	4x19
30	122	15	75	11	18	12	4x19
30	130	15	75	11	18	12	4x19
40	158	19	106	11	22	16	5x22
40	170	19	106	11	22	16	5x22

	V	W	X
GL-13-□			
GL-20-□	69	55	
GL-25-5			
GL-25-10	93	125	50
GL-32-□			
GL-40-5	93	125	50
GL-40-10	103	140	63
GL-50-5			
GL-50-10	115	160	80

GL-13-□,
GL-20-□,
GL-25-5

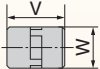

GL-25-10,
GL-32-□,
GL-40-□,
GL-50-□

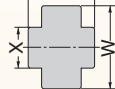

GB— GC—

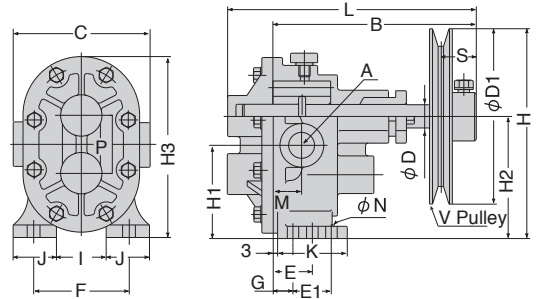

Type	A	L	B	C	D	D1	H	H1	H2	H3
GC-13/GB-13	G $\frac{1}{2}$ "	181	148	100	18	127	151	67	88	130
GC-20/GB-20	G $\frac{3}{4}$ "	201	165	130	20	152	179	78	103	153
GC-25/GB-25	G1"	247	204	142	22	203	230	91	129	191

F	J	I	K	E	G	E1	N	M	P	S	Pulley
70	32	36	51	33	—	—	9	21	41	25	A1
97	36	58	30	—	23	28	9	25	50	25	A1
114	38	65	75	—	30	34	10	33	63	24	A1

FS PUMP

FS-12D FS-24D

Cord Tip Shape

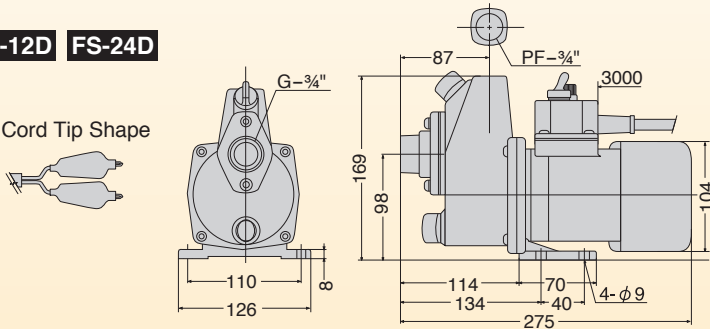

FILL PUMP

FR-200

Cord Shape
FD-12
FD-24

FA-100
FR-200

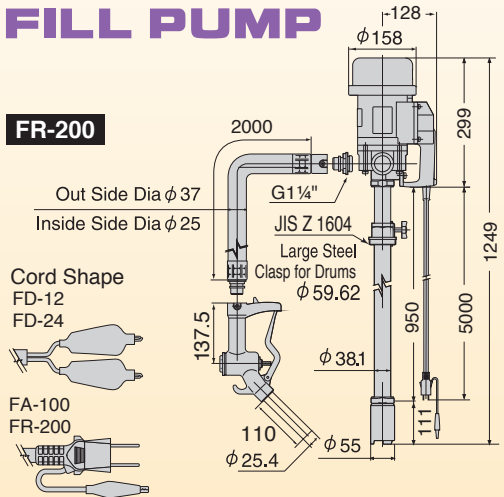

CHANGE-MASTER

GM-2524H

Cord Tip Shape

A Code Length:5000

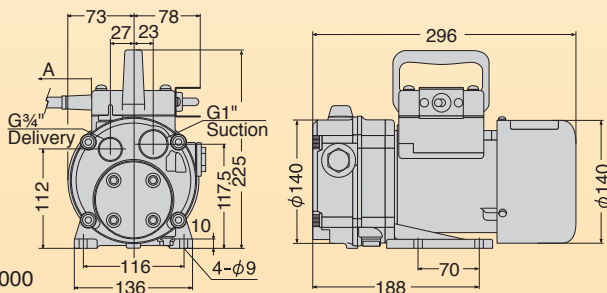

FD-12

FD-24

FA-100

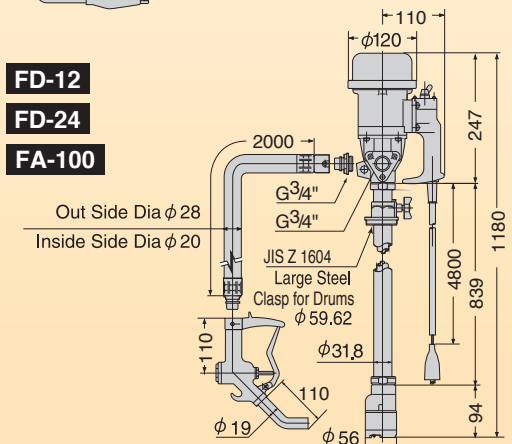

FOR FISHERY INDUSTRY

Light weight & Compact Most Suitable for Fishing Boats

■ Applications

- Winding anchor for boats
- Drawing fishing net
- Towing line
- Winding up basket

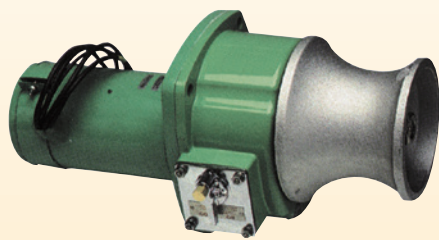

REL-2512



RES-2512

■ Performance Curve

• RES-2512, REL-2512 (250 W, 12 V Type)

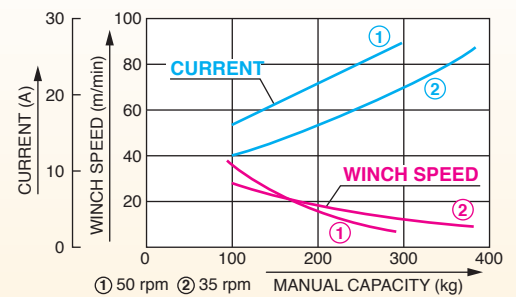

• RES-4024, REL/RES-4024 (400 W, 24 V Type)

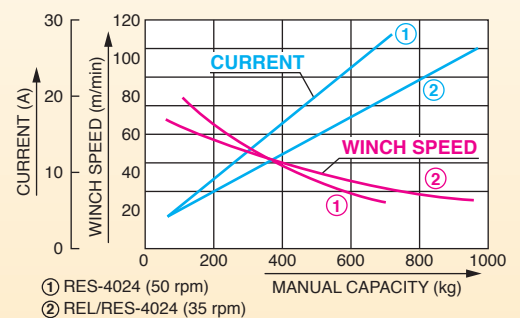

■ Specification

Model	RES-2512	REL-2512	RES-4024	REL-4024	RES-4024L	REL-4024L
Voltage	DC 12 V			DC 24 V		
Rated Current	30 A			25 A		
Motor Output	250 W			400 W		
Rating	1 h / 30 A			1 h / 25 A		
Roller Revolution	50 rpm (Low), 100 rpm (High)		50 rpm (Low), 100 rpm (High)		35 rpm (Low), 70 rpm (High)	
Manual Capacity	Max. 280 kg (Low), 140 kg (High), (90 A)		700 kg (Low), 350 kg (High)		900 kg (Low), 450 kg (High)	
	Rating 90 kg (Low), 45 kg (High), (30 A)		140 kg (Low), 70 kg (High), (25 A)		200 kg (Low), 100 kg (High), (25 A)	
Winch Speed (With 100 kg Load)	6 m/min (19 ft/min) (Low)		20 m/min (65 ft/min) (Low)		13 m/min (49 ft/min) (Low)	
	13 m/min (42 ft/min) (High)		33 m/min (108 ft/min) (High)		23 m/min (82 ft/min) (High)	
Standard Accessories	1 Cable Gland for Ship, 1 Waterproofing Plate, 1 Vertical Type Main Body Packing, 5 Crimping Terminals, 1 Connection Terminal					
Net Weight	15.5 kg (34.1 lbs)	14.6 kg (32.1 lbs)	21.5 kg (47.3 lbs)	18.9 kg (41.6 lbs)	24.6 kg (54.2 lbs)	19.2 kg (42.3 lbs)
Gross Weight	18.5 kg (40.7 lbs)	15 kg (33 lbs)	24.2 kg (53.3 lbs)	20.0 kg (44.0 lbs)	26.4 kg (58.2 lbs)	20.5 kg (45 lbs)
Dimensions LxWxH (mm)	560 x 240 x 280	468 x 235 x 270	560 x 240 x 280	469 x 237 x 255	560 x 265 x 270	469 x 237 x 255
Packing Unit	1					

High Speed & High Load Rolling Up Max. Winch Up Power 900 kg

- Use magnet motor. Simple wiring and easy to switch direction between clockwise to counterclockwise.
- Approx. 25 % more power from usual 400 W type by high speed and high load rolling up.
- 2 stage switchable winch capacity (REL, RES).
Switch to 900 kg / 50 rpm and 450 kg / 100 rpm by gearshift.
- Motor case, Roller, etc are made of aluminum alloy.
Light, compact, sea water proof and no rust damage to FRP boat.
- Polyurethane coat protects corrosion perfectly.

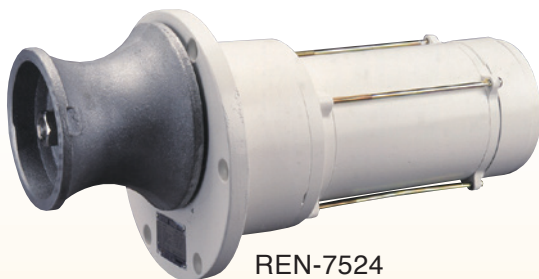

Performance Curve

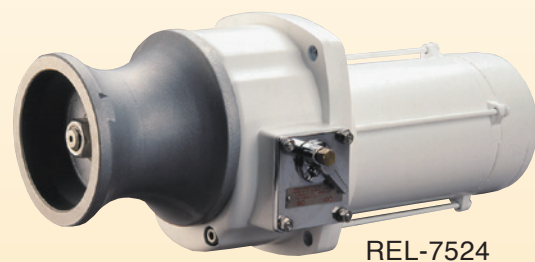
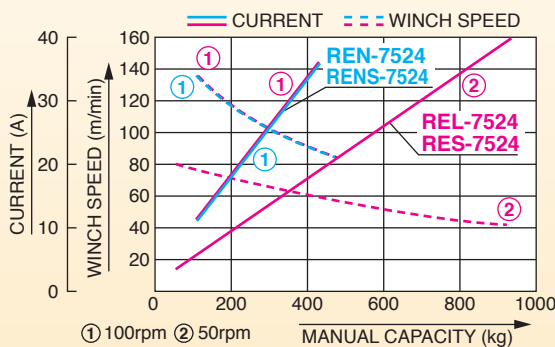

Specification

Model	REN-7524	RENS-7524	REL-7524	RES-7524
Voltage	DC 24 V			
Rated Current	43 A			
Motor Output	750 W			
Rating	1 h / 43 A			
Roller Revolution	100 rpm		50 rpm (Low), 100 rpm (High)	
Manual Capacity	Max.	450 kg (150 A)	900 kg (Low), 450 kg (High), (150 A)	
	Rating	110 kg (43 A)	220 kg (Low), 110 kg (High), (43 A)	
Winch Speed	33 m/min (108 ft/min)		17 m/min (55 ft/min) (Low), 33 m/min (108 ft/min) (High)	
Standard Accessories (RES, REN Type Only)	1 Cable Gland For Ship, 1 Waterproofing Plate, 1 Vertical Type Main Body Packing, 2 Crimping Terminals			
Net Weight	20.5 kg (45 lbs)	30.5 kg (67 lbs)	19.5 kg (43 lbs)	25 kg (55 lbs)
Gross Weight	25 kg (55 lbs)	35 kg (77 lbs)	24 kg (53 lbs)	30.5 kg (67 lbs)
Dimensions LxWxH (mm)	500 × 270 × 275	575 × 305 × 315	510 × 270 × 255	560 × 265 × 270
Packing Unit	1			

Effective Electromagnetic Brake Model

- Motor case is made of corrosion resistance aluminum alloy to withstand seawater.
- Possible to stop instantly.

■ Applications

- Winding anchor for boats
- Drawing fishing net
- Towing line
- Winding up basket



REL-5524LB



RES-5524LB

■ Specification

Model		RES-5524LB	REL-5524LB
Voltage		DC 24 V	
Rated Current		31 A	
Motor Output		550 W	
Rating		1 h / 31 A	
Roller Revolution		35 rpm (Low), 70 rpm (High)	
Manual Capacity	Max.	1000 kg (Low), 500 kg (High)	
	Rating	280 kg (Low), 140 kg (High)	
Winch Speed (With 100 kg Load)		13 m/min (42 ft/min) (Low) 23 m/min (75 ft/min) (High)	
Electromagnetic Brake	Static Friction Torque	4 N·m (0.4 kgf·m)	
	Rated Voltage	DC 24 V	
	Rated Capacity	15 W	
Standard Accessories		1 Waterproofing Plate, 1 Vertical Type Main Body Packing, 5 Machine Screws M5×20	
Net Weight		29.8 kg (65.6 lbs)	20.8 kg (45.8 lbs)
Gross Weight		32.2 kg (70.9 lbs)	22.4 kg (49.3 lbs)
Dimensions L×W×H (mm)		583 × 320 × 340	540 × 248 × 278
Packing Unit		1	

■ Performance Curve

• RES-5524LB, REL-5524LB (550 W, 24 V Type)

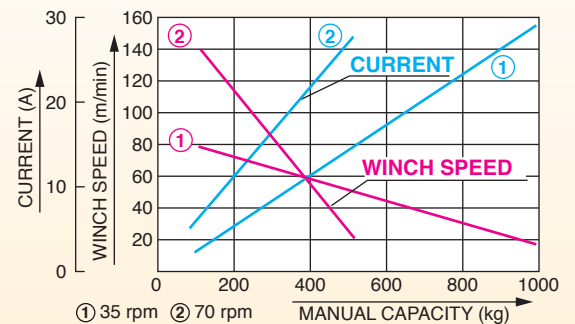

ECARL BOX Just Changing Box Makes Your ECARL New

Example:
REL+REF



RES-330A
Suitable model:
• All REL model



RES-330B
with 3-button switch
Suitable model:
• All REL model



REF-300
Suitable model:
• REL-2512
• REL-2524
• REL-4024
• REL-4024L



REF-330
Suitable model:
• All REL model



3-button switch
Suitable model:
• RES-330B
• Attached to REF-330

Long Life Span with Titan Boron Alloy

■ Features

- Compact and light
- The switch is installed on the back or side of the main body.
- Both right-handed and left-handed can be used.
- Only one switch for start and stop.
- Alumite coating for high durability anti-rusting



RN-2012



RN-2012H

■ Performance Curve

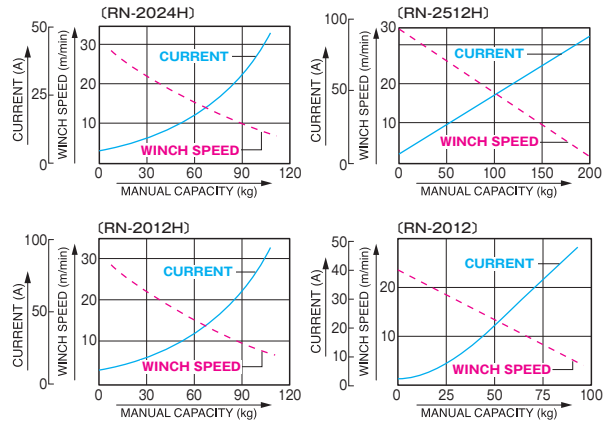

■ Specification

Model	RN-2012	RN-2012H	RN-2024H	RN-2512H
Voltage	DC 12 V		DC 24 V	DC 12 V
Rated Current	15 A	24 A	13 A	30 A
Motor Output	140 W		200 W	250 W
Rating	1 h / 15 A	1 h / 24 A	1 h / 13 A	1 h / 30 A
Roller Revolution	100 rpm (No Load)			120 rpm (No Load)
Manual Capacity	Max.	50 kg (45A)	120 kg (85A)	120 kg (40A)
	Rating	35 kg (15A)	50 kg (24A)	50 kg (130A)
Winch Speed	27 m/min (88 ft/min)		32 m/min (105 ft/min)	
Breaker	15 A	30 A	20 A	30 A
Standard Accessories	1 Waterproofing Plate, 1 Vertical Type Main Body Packing, 5 Machine Screws M5x20			
Net Weight	11.5 kg (25.3 lbs)	16.2 kg (35.7 lbs)	16.9 kg (37.2 lbs)	
Gross Weight	12.5 kg (27.5 lbs)	17.3 kg (38.1 lbs)	18.0 kg (39.6 lbs)	
Dimensions LxWxH (mm)	425 x 260 x 285	445 x 270 x 290	450 x 270 x 290	
Packing Unit	1			

*Set the anchor and rope weight less than half as a manual capacity.

For pulling up the anchors of leisure and motor boats

■ Features

- Easy to pull up the anchor with a single switch
- Right-handed, left-handed free installation
- Easy to use. Just need to wire to the battery.
- High anti-discoloration with denatured epoxy paint



RES-2012H



RED-2012H

■ Performance Curve

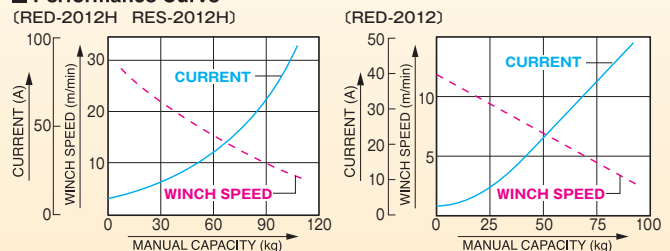

■ Specification

Model	RED-2012H	RES-2012H	RED-2012
Voltage	DC 12 V		
Rated Current	24 A	15 A	
Motor Output	200 W	140 W	
Rating	1 h / 24 A	1 h / 15 A	
Roller Revolution	100 rpm (No Load)	50 rpm (No Load)	
Manual Capacity	Max.	120 kg (85 A)	100 kg (45 A)
	Rating	50 kg (24 A)	40 kg (15 A)
Winch Speed	27 m/min (88 ft/min)	11.5 m/min (37 ft/min)	
Breaker	30 A	15 A	
Standard Accessories	1 Waterproofing Plate, 1 Vertical Type Main Body Packing, 5 Machine Screws M5x20		
Net Weight	13.5 kg (29.7 lbs)	8.5 kg (18.7 lbs)	
Gross Weight	14.0 kg (30.8 lbs)	8.5 kg (18.7 lbs)	
Dimensions LxWxH (mm)	440 x 235 x 280	349 x 235 x 275	
Packing Unit	1		

*Set the anchor and rope weight less than half as a manual capacity.

Compact Built-in Type

■ Features

- REP type allows to work while standing.
- For anchoring, recommend to use anchor davit (optional) together.



REP-2512H

■ Performance Curve

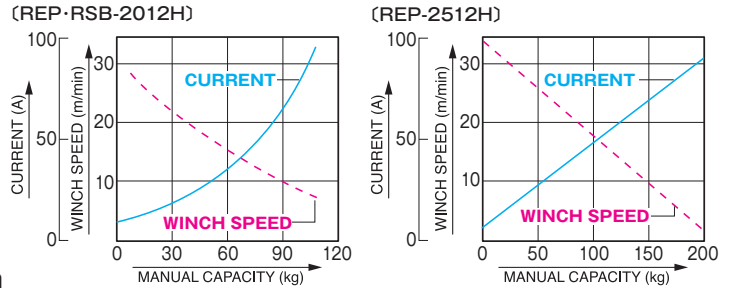

■ Specification

Model		REP-2012H	REP-2512H
Voltage		DC 12 V	
Rated Current		24 A	30 A
Motor Output		200 W	250 W
Rated Current		1 h / 24 A	1 h / 30 A
Roller Revolution		100 rpm (No Load)	120 rpm (No Load)
Manual Capacity	Max.	120 kg (85 A)	200 kg (110 A)
	Rating	50 kg (24 A)	60 kg (30 A)
Winch Speed		27 m/min (88ft/min)	32 m/min (105ft/min)
Breaker		30 A	30 A
Standard Accessories		1 Breaker, 1 Power cord (5.5mm ² x 10m x 2 cores), 2 Nut (M4), 1 Packing, 2 Screws (M4x8), 4 Soldered Terminals	
Net Weight		—	—
Gross Weight		—	—
Dimensions LxWxH (mm)		—	—
Packing Unit		1	

*Set the weight of the anchor + rope with a weight that is less than half of the hoisting capacity (normal use) as a guide.

Rolling Up Smoothly Without Damage to Net

■ Features

- Dual-speed roller revolution (No load): 20-30 rpm and 40-60 rpm.
- With 2-stage-switch and free revolution (20-60 rpm).
- For use, just connect to battery and after use, easy to take off.
- Roller itself and stand have a handle.
- Possible to set roller to any direction.
- Traverse switch makes it possible to do wide variety of work.



MR-2512



■ Specification

Model		MR-2512	MR-4024
Voltage		DC-12V	DC-24V
Rated Current		30A	25A
Motor Output		250W	400W
Rating		1h/30A	1h/25A
Roller Revolution (No Load)	20 rpm, Low	20~30rpm	
	40rpm, High	40~60rpm	
Manual Capacity	Max. (2min)	20 rpm, Low: 250kg	900kg
	Rating (1hr)	40rpm, High: 125kg	450kg
		20 rpm, Low: 80kg	200kg
	40rpm, High: 40kg	100kg	
Winch Speed	20 rpm, Low	12m/min (39ft/min)	16m/min (52ft/min)
	40rpm, High	22m/min (72ft/min)	30m/min (98ft/min)
Net Weight		36 kg (79.3 lbs)	38 kg (83.7 lbs)
Gross Weight		44.2 kg (97.4 lbs)	47.7 kg (105.1 lbs)
Dimensions LxWxH (mm)		685 x 588 x 308	
Packing Unit		1	

Pollers (Options)

*Set the weight of the anchor + rope with a weight that is less than half of the hoisting capacity (normal use) as a guide.

■ Limits of use (20rpm set)

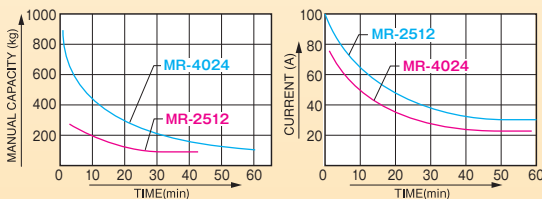

■ Performance Curve (20rpm set)

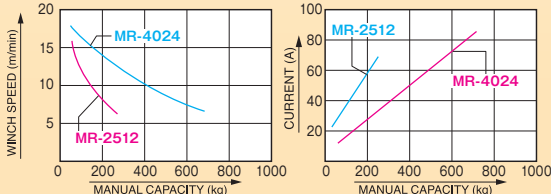

"NEW BILGE KING" Necessities for Boat

- Auto-stop feature prevents dry running, increases pump performance and life.
- Easy to use starter switch. Integrated fuse and switch assembly for ease of maintenance. Separate switch can be attached anywhere you want.
- Strainer and switch are specially made for sea water and oil resistible resin for long durability.
- Two stage system of axial flow vane and spiral vane
- Easy to clean strainer.

■ Applications

- Draining of water and oil/water mix from bilge



BK-12

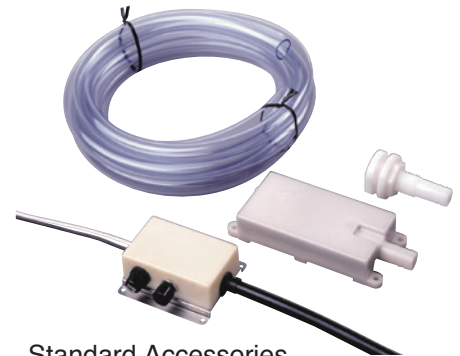

Standard Accessories

Type S is Pump only without Accessories Replacement for "BILGE PUMP"



BK-12S

How to Attach Pump

Attach pump at 45 degree angle to set suction mouth and delivery mouth face upper side with 4 screws ($\phi 5 \times 10$). (See the picture below)

In a dry place, attach pump to the side of boat about 50 to 70 cm away from the bottom of the boat.

Choose the location to set the pump by considering the length of battery and starting switch cable (3 m).

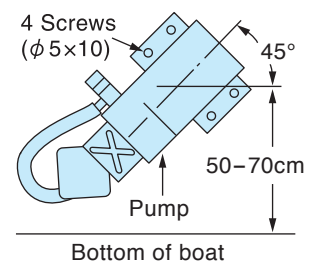

■ Specification

Model	BK-12	BK-12S	BK-24	BK-24S
Suction / Delivery Dia	15 mm (1/2")			
Max. Delivery Volume	20 L/min (5 USG/min)			
Voltage	DC 12 V		DC 24 V	
Rated Current	10 A		5 A	
Suction Lift	1 m (3 ft)			
Suction Time	2 - 5 sec (20 °C)			
Rating	80 W		90 W	
Standard Accessories (*Type S : Not Included)	1 Code with Starting Switch, 4 Tapping Screws (5x10), 4 Tapping Screws (4x16),	1 Strainer, 4 Tapping Screws (4x20), 1 Water Proofing Connector (Only S Type)	1 Delivery Nozzle, 4 Tapping Screws (4x10),	1 Delivery Nozzle Nat, 1 Hose (3 m),
	1 Fuse (15 A)		1 Fuse (8 A)	
Net Weight	3.6 kg (7.9 lbs) (1 unit)	2.3 kg (5.1 lbs) (1 unit)	3.6 kg (7.9 lbs) (1 unit)	2.3 kg (5.1 lbs) (1 unit)
Gross Weight	18.5 kg (41 lbs) (4 units)	10 kg (22 lbs) (4 units)	18.5 kg (41 lbs) (4 units)	10 kg (22 lbs) (4 units)
Dimensions LxWxH (mm)	485 x 323 x 346	330 x 296 x 250	485 x 323 x 346	330 x 296 x 250
Packing Unit	4			

*BK-12S, BK-24S is pump for replacement.

"REVOLVEX PUMPS" Flexible Rubber Impeller for Seawater



- Complete structure is manufactured from gunmetal, no rusting.
- START/STOP is easily controlled by pressing one switch. (MFC type)
- MFC type is fitted with electromagnetic clutch.
- Easy to replace rubber impeller.
- Self-priming.

Performance Curve

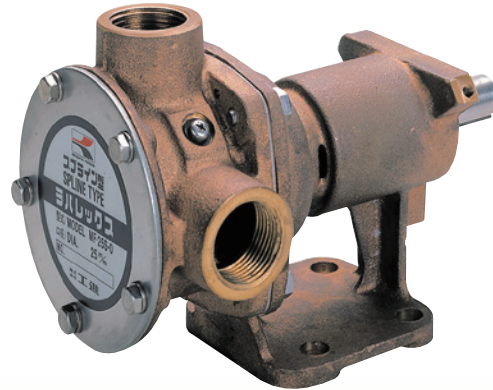
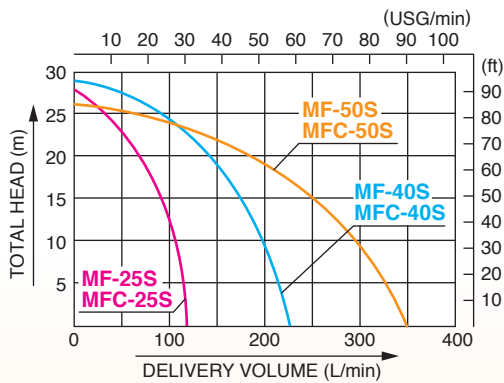

MF-25S

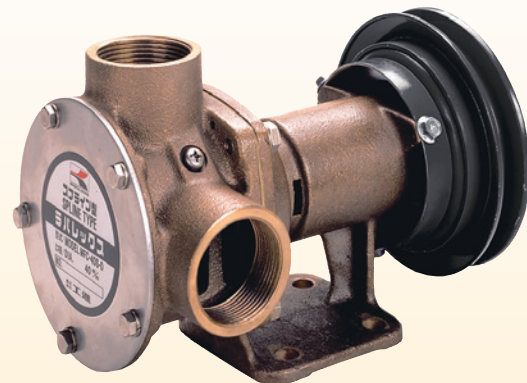
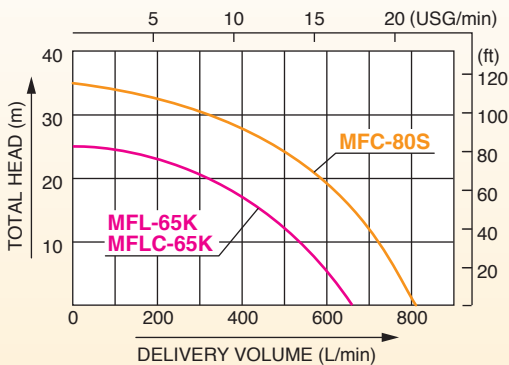

MFC-40S

For Seaweed Model Pumping Up Seaweed at Once, And Transferring it without Damage



- Adopted special impeller to avoid damage by seaweed.
- Special sleeve to transfer seaweed smoothly.

Applications

- Transfer seaweed from small boat to mother ship
- Built in for the machinery for seaweed
- Discharge of bilge water, emergency water discharge
- Washing a deck or hold

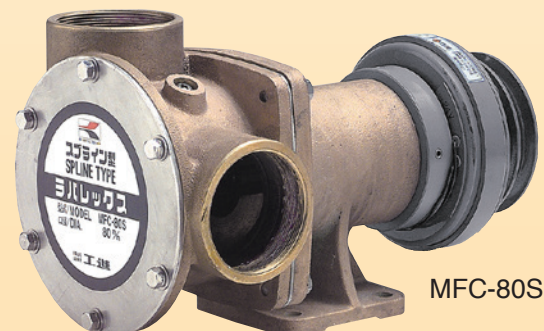

MFC-80S

Specification

(*Products by order)

Model	MF-25S	MF-40S	MF-50S	MFC-80S*	MFLC-65K*	MFL-65K*
Connection Dia	25 mm (1")	40 mm (1½")	50 mm (2")	80 mm (3")	65 mm (2½")	
Connection Thread	Inner Pipe Thread					
Material	Bronze Castings (Gunmetal)					
Total Head	28 m (92 ft)	29 m (95 ft)	26 m (85 ft)	35 m (114 ft)	24 m (78 ft)	
Delivery Volume	115 L/min (30 USG/min)	215 L/min (56 USG/min)	350 L/min (92 USG/min)	820 L/min (216 USG/min)	650 L/min (171 USG/min)	
Output	1.5 kw (2.0 PS) / 1750 rpm		3.7 kw (5.0 PS) / 1750 rpm	7.5 kW (10.2 PS) / 1,750 rpm	5.5 kW (7.5 PS) / 1,750 rpm	
Number of Blades	9			13	6	
Driving Method	Belt Drive					
Revolution Direction	Anti-clockwise (Watching from Driving Shaft)					
Revolution	500 – 2300 rpm					
Shaft Dia	20 mm (¾")		25 mm (1")	Electromagnetic Clutch		25 mm (1")
Standard Accessory	Parallel Key					
Net Weight	4.7 kg (10.3 lbs)	5.7 kg (12.5 lbs)	8.7 kg (19.1 lbs)	—————	23.5 kg (51.8 lbs)	18.5 kg (40.7 lbs)
Gross Weight	—————		9.1 kg (21 lbs)	—————	25 kg (55 lbs)	20 kg (44 lbs)
Dimensions LxWxH (mm)	240 × 142 × 183	260 × 158 × 191	342 × 162 × 214	420 × 230 × 265	450 × 224 × 270	450 × 224 × 270
Packing Unit	1					

Electromagnetic Clutch Specifications

*In case power is supplied by general purpose engine, choose MFC series (with clutch). (Need power source for clutch.)

*12V Clutch is available as option

Model	MFC-25S	MFC-40S	MFC-50S
Pump	MF-25S	MF-40S	MF-50S
Voltage (Clutch)	DC 24 V		
Capacity (Clutch)	43 W		45 W
Pulley	φ 136.5 (B-1)		φ 130 (B-2)
Net Weight (Clutch)	7.6 kg (16.7 lbs)	8.8 kg (19.4 lbs)	15.9 kg (35.0 lbs)
Gross Weight	—————	9.5 kg (20.9 lbs)	18.3 kg (40.3 lbs)
Dimensions LxWxH (mm)	262 × 150 × 190	282 × 168 × 183	364 × 192 × 214
Packing Unit	1		

Model	MFC-80S MFLC-65K
Voltage	DC 24 V
Capacity	36 W
Pulley	φ 130

MF Series Impeller List

For "REVOLVEX PUMPS" & "RUBBER MASTER"

Spline Type Impeller

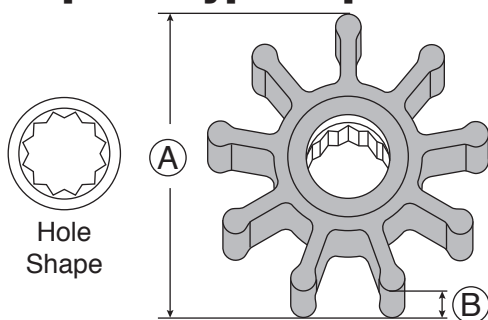

MF-25SRL (For MF-25S) (For Seawater)

Key Type Impeller

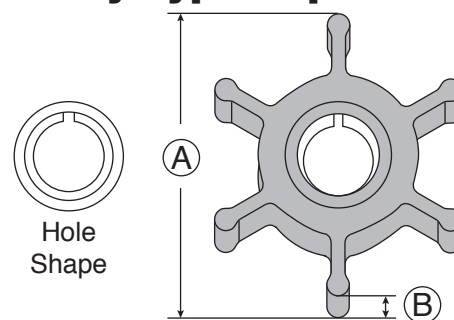

MFL-65KR (For MFL-65K, MFLC-65K) (For Seawater)

Model	MF-25S MFC-25S	MF-40S MFC-40S	MF-50S MFC-50S MFC-50SX	MFC-65K	MFL-65K MFLC-65K	MFC-80S	MF-40MS	MF-2524	MF-4024X	
Application	Seawater							Oil	Seawater	
Impeller Model	MF-25SRL	MF-40SRL	MF-50SRL	MF-65KR	MFL-65KR	MF-80SR	MF-40SRL	MF-2524KR	MF-2524KN	MF-4024KR
(A) Outside Dia	80 mm	94 mm		128.5 mm		143 mm	94 mm	65 mm		90 mm
(B) Thickness	54 mm	63 mm	95 mm	102 mm		105.4 mm	63 mm	41 mm		46 mm
Number of Blades	9			11	6	13	9	8		
Shape of Shaft	Spline			Key		Spline		Key		
Material	Chloroprene Rubber (Neoprene)							Nitrile Butyl Rubber	Chloroprene Rubber (Neoprene)	

Long Durability "REVOLVEX PUMP"

- Compact design and can be removed on the deck easily.
- Small and compact, but, large delivery volume for this class of pumps.
- Continuous running is available with motor fun.
- Dry prime pump, no need to prime with water, immediate suction.

**Easy to Remove
in The Ship**



MF-40MS

**Easy to Replace
Carbon Brushes**

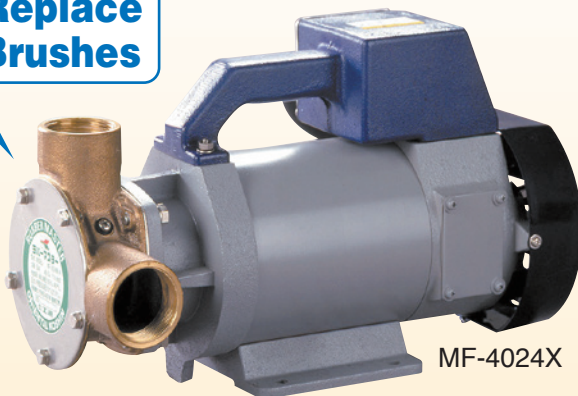

MF-4024X

* To transfer fuel, please use special impeller for oil. (Impeller type : MF-2524KN)
Please refer to page 51.

Performance Curve

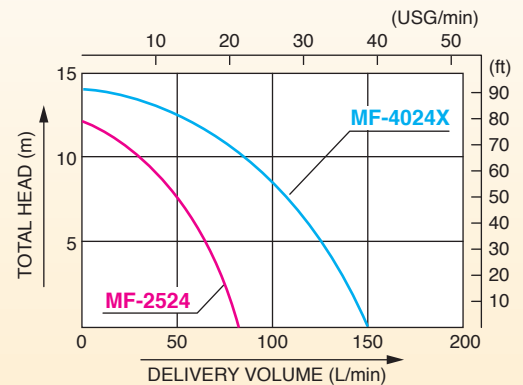
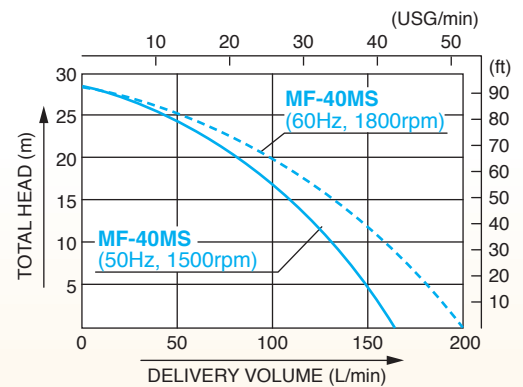

Specification

Model		MF-40MS	MF-2524	MF-4024X
PUMP	Connection Dia	40 mm (1½")	25 mm (1")	40 mm (1½")
	Connection Thread	Inner Pipe Thread		
	Material	Bronze Castings (Gunmetal)		
	Total Head	29 m (95 ft)	9 m (29.5 ft)	14 m (45.9 ft)
	Max. Suction Lift	5 m (16 ft)	3.5 m (11 ft)	
	Delivery Volume	60 Hz : 200 L/min (52 USG/min) 50 Hz : 170 L/min (44 USG/min)	80 L/min (21 USG/min)	150 L/min (39 USG/min)
MOTOR	Voltage	Three Phase 200 V		DC 24V
	Current	6.8 A / 50 Hz 6.0 A / 60 Hz	12 – 15 A	22 – 30A
	Output	1.5 kW	250 W	400 W
	Power Cord	10 m (1.25 mm ²)	5 m (2 mm ²)	5 m (3.5 mm ²)
Standard Accessories	1 Strainer, 1 Hose Band (φ48)	1 Strainer, 2 Connecting Nipples (φ25), 3 Hose Bands (φ32)		1 Strainer, 1 Hose Band (φ48)
Net Weight	29.8 kg (66 lbs)	8.3 kg (18 lbs)	22 kg (49 lbs)	
Gross Weight	34.2 kg (75 lbs)	8.8 kg (19.4 lbs)	22.7 kg (50 lbs)	
Dimensions LxWxH (mm)	488 × 244 × 344	315 × 213 × 238	420 × 220 × 280	
Packing Unit		1		

"FS PUMPS" Marine Self-priming Pump for Seawater

- Specially designed for use with seawater.
- Pump and motor are constructed to withstand seawater and operated by DC 24V power source.
 1. Seawater proof motor: These motors are specially designed for seawater applications.
 2. Special aluminum compound for motor casing is made to withstand seawater corrosion.



FS-3224S

Specification

Model		FS-2024S	FS-3224S
PUMP	Connection Dia	20 mm (3/4")	32 mm (1 1/4")
	Connection Thread	Inner Pipe Thread	
	Total Head	9 m (30 ft)	18.5 m (60 ft)
	Delivery Volume	50 L/min (13 USG/min)	100 L/min (26 USG/min)
MOTOR	Voltage	DC 24 V	
	Rated Current	7 A	16 A
	Output	90 W / 7000 rpm	200 W / 6200 rpm
	Rating	Continuous	
	Power Cord	3 m (10 ft)	5 m (16 ft)
Standard Accessories	1 Strainer, 2 Hose Nipples, 1 Set Carbon Brush		
Net Weight	4.5 kg (10 lbs)(1 unit)	7.8 kg (17 lbs)(1 unit)	
Gross Weight	28.5 kg (62.8 lbs)(5 units)	28 kg (62 lbs)(3 units)	
Dimensions LxWxH (mm)	780 x 295 x 237	555 x 385 x 325	
Packing Unit	5	3	

Performance Curve

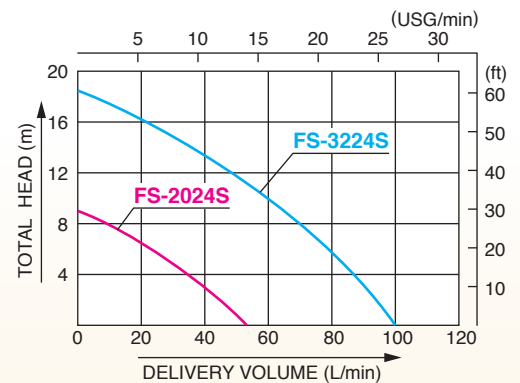

OUTLINE DRAWING

REVOLVEX PUMP

MF-40MS

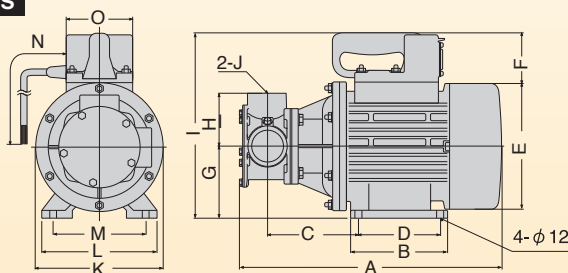

Model	A	B	C	D	E	F	G	H	I	J	K	L	M	N	O
MF-40MS	407	150	143	120	200	90	105	80	293	Rp1/2"	200	170	140	9700	120

RUBBER MASTER

MF-2524

MF-4024X

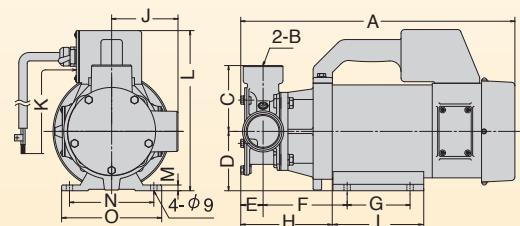

Model	A	B	C	D	E	F	G	H	I	J	K	L	M	N	O
MF-2524	281.5	Rp1"	63	60	29	119.5	66	133.5	96	63	5000	205	10	100	120
MF-4024X	386	Rp1/2"	95	83	31.5	118.5	88	129	128	95	5000	226.5	8	118	140

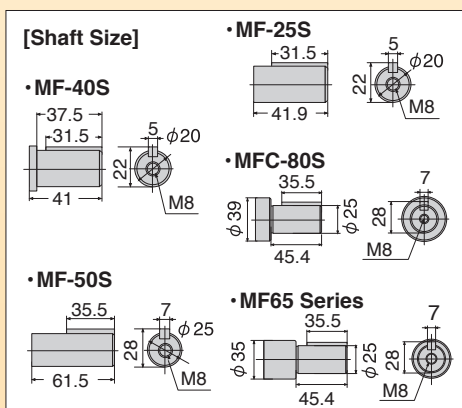

MF- MFC-

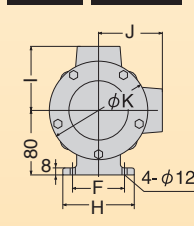

MFC-80S

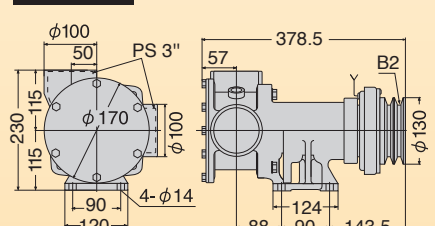

Model	A	B	C	D	E	F	G	H	I	J	K	L	M	N(Pulley)
MF-25S·MFC-25S	Rp1"	219(234)	60	72(864)	50	60	85	85	70	70	108	136.5	80	B1
MF-40S·MFC-40S	Rp1 1/2"	232(247)	62.5	74(88)	55	65	90	90	80	80	123	136.5	80	B1
MF-50S·MFC-50S	Rp2"	311(335)	90.5	85.5(108.5)	80	80	105	105	95	95	123	130	91	B2
MFL(C)-65K·MFC-65K	Rp1/2"	384(403)	105	124.5(143.5)	90	90	120	120	115	115	170	130	115	B2

NEW BILGE KING

[Deriverty Nozzle]

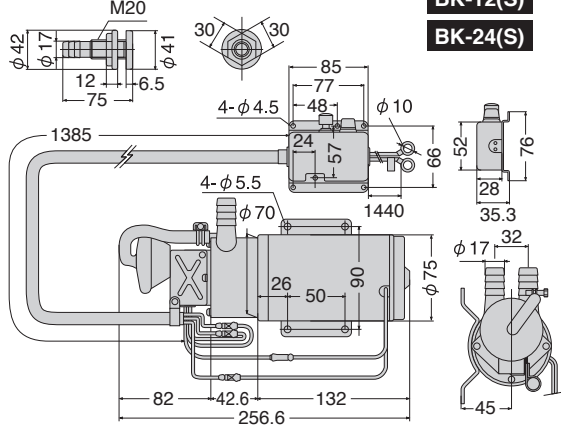

BK-12(S)

BK-24(S)

FS PUMP

FS-2024S

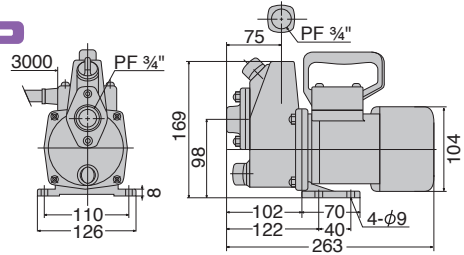

FS-3224S

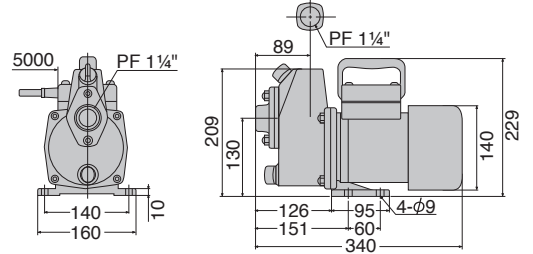

MINI ECARL

RN-2012H

RN-2512H

RN-2024H

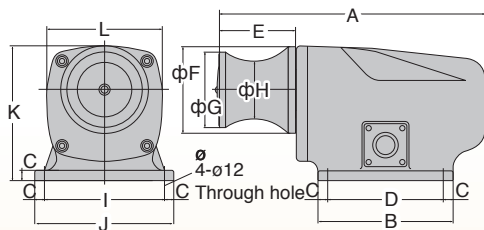

MODEL	A	B	C	D	E	F	G	H	I	J	K	L
RN-2012H	403											
RN-2512H	433	205	15	175	116	132	114	87	180	210	203	174
RN-2024H	403											

RED-2012H

RED-2024H

RED-2012

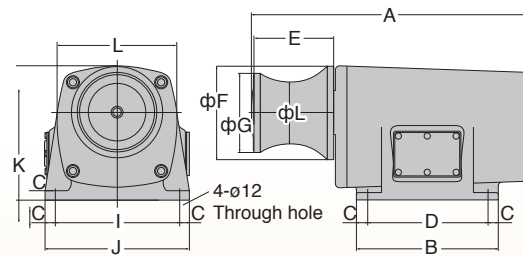

MODEL	A	B	C	D	E	F	G	H	I	J	K	L
RED-2012H	402.5											
RED-2012	335.5	205	15	175	116	132	114	87	180	210	192	174

RN-2012

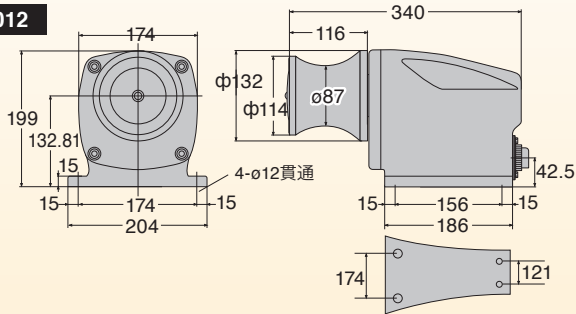

RES-2012H

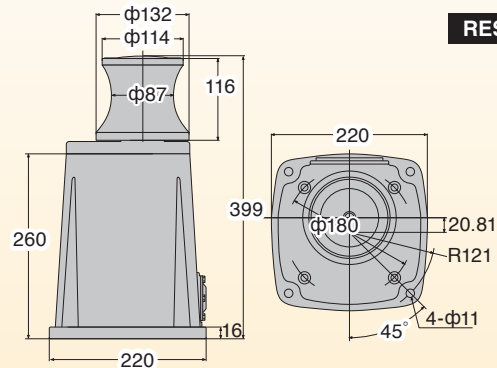

Common to all shaft models

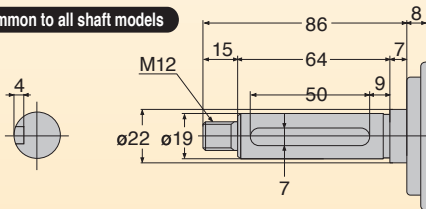

MINI ECARL

REP-2012H

REP-2512H

()2512H

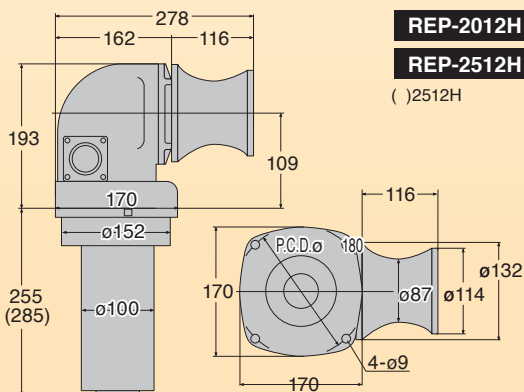

RSB-2012H

RSB-2512H

()2512H

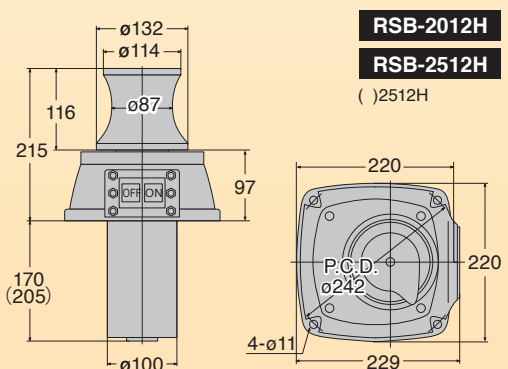

ECARL BOX

RES-330A
RES-330B

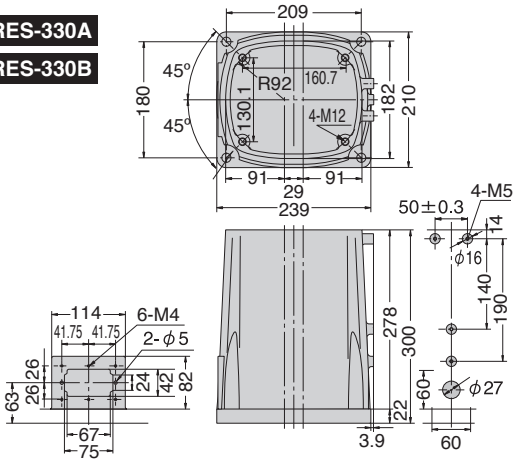

REF-300

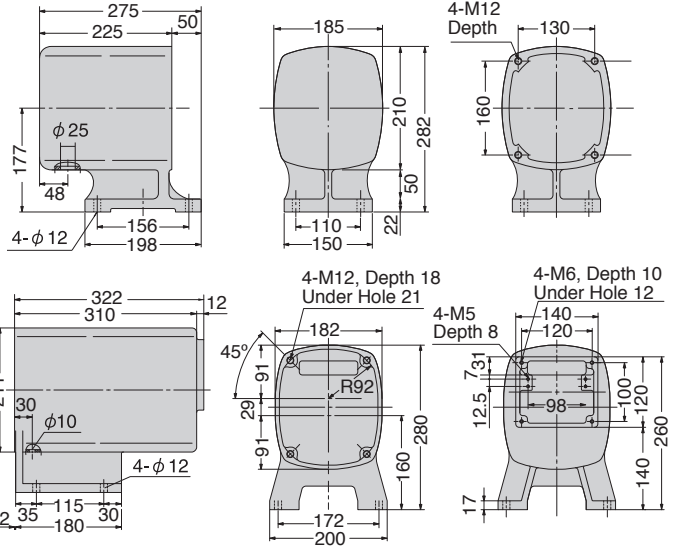

ECARL

[Shaft Size]

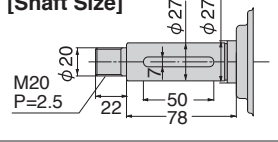

REL-5524LB

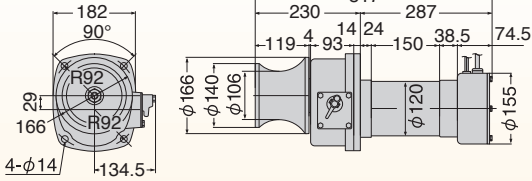

RES-5524LB

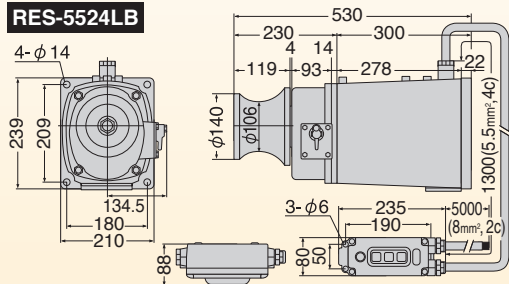

RES-2512

RES-4024(L)

RES-7524

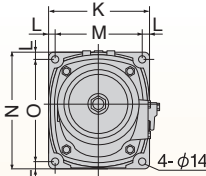

RENS-7524

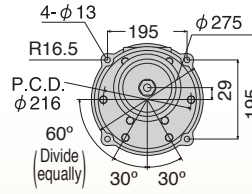

REN-7524

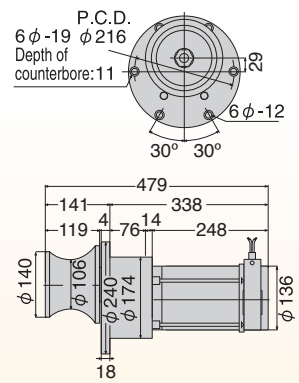

REL-2512

REL-2524

REL-4024(L)

REL-7524

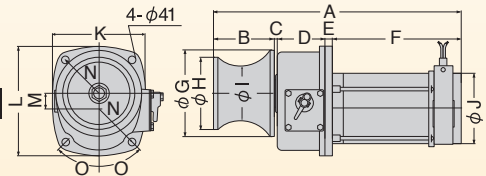

Model	A	B	C	D	E	F	G	H	I	J	K	L	M	N	O
RES-2512	530														
RES-4024(L)		119	4	93	14	278	22	166	140	106	210	15	180	239	209
RES-7524	532		6												

Model	A	B	C	D	E	F	G	H	I	J	K	L	M	N	O
REL-2512(L)	427					197					113	182			
*REL-2524		119	4	93	14	203	166	140	106		136	182	211	29	R92 45°
REL-4024(L)	433														
REL-7524	480		6			248									

*REL-2524 is discontinued

MAG ROLLER

MR-120 **MR-240** **MR-360**
MR-25 **MR-2512** **MR-4024**

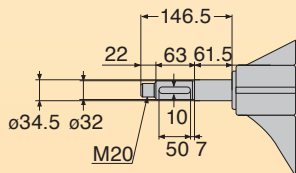

Shaft Dimensions

MODEL	A	B	C
MR-120	210	110	689.5
MR-240	328	228	807.5
MR-360	446	346	925.5

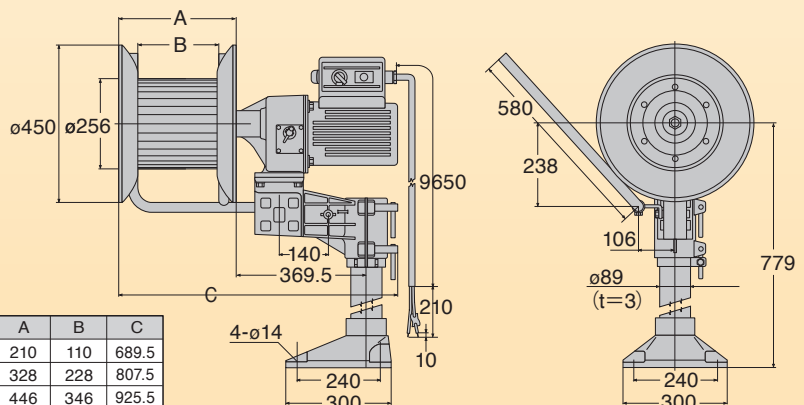



GARDEN SPRAYERS

BACK PACK TYPE ENGINE SPRAYER



Suitable for weeding
*Cascade type
Super light!



ES-10CDX

Herbicide for
big farm (20L Tank)



ES-20C

Easy engine start with carrying
the sprayer on your back.
(*only 10CDX and 15CDX.
ES-20C does not have this function)



With plug for preventing
frozen fertilizer

Nozzle length 60cm

Nozzle connection
screw type G 1/4



Vertical 2-head
nozzle for
disinfection

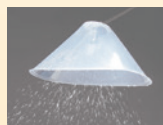

Bubble type
herbicide nozzle
with cover (*only
10CDX and 15CDX)
for herbicide.



Bubble type
herbicide nozzle
(*only ES-20C)
for herbicide.

Specification

Model		ES-10CDX*	ES-15CDX*	ES-20C*
PUMP	Tank Capacity	10 L	15 L	20 L
	Type	Cascade type		
	Max. Pressure (At closing)	0.8 MPa (8 kgf/cm ²)		
	Max. Suction Volume	6 L/min (1.58 USG/min)		
ENGINE	Spray Volume	Vertical 2-head Nozzle, : 2 L/min Bubble Type Herbicide Nozzle (with Cover): 0.6 L/min		
	Nozzle	Bubble Type Herbicide Nozzle with Cover•Vertical 2-head Nozzle		Bubble Type Herbicide Nozzle, Vertical 2-head Nozzle
	Type	Forced Air-cooled 2-stroke Gasoline Engine		
	Model	Koshin KC 22-C		
	Total Displacement Volume	22.6 cc		
	Continuous Operation Time	Approx. 50 min		
	Net Weight	5.7 kg (12.5 lbs)	5.9 kg (13 lbs)	6.3 kg (14 lbs)
	Gross Weight	8.0 kg (18 lbs)	8.5 kg (18.7 lbs)	9.0 kg (20 lbs)
	Dimensions LxWxH (mm)	420 x 410 x 480	420 x 410 x 545	450 x 390 x 567
	Packing Unit	1		

*Japanese Domestic Model

High Pressure Single Piston Type



Application for weeding and disinfection



ES-10PDX



ES-20PDX

Nozzle length 60cm

Nozzle connection screw type G 1/4



Vertical 2-head nozzle for disinfection

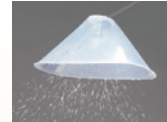

Bubble type herbicide nozzle with cover (*only 20PDX and 15PDX) for herbicide.

Specification

Model		ES-10PDX*	ES-15PDX*	ES-20PDX*
PUMP	Tank Capacity	10 L	15 L	20 L
	Type	Single piston type		
	Max. Pressure (At closing)	3.0 Mpa (30kgf/cm ²)		
	Max. Suction Volume	5.2 L/min (1.37 USG/min)		
ENGINE	Spray Volume	3.5 L/min : Vertical 2-head (High pressure mode), 0.63 L/min : Bubble Type Herbicide Nozzle (Herbicide mode)		
	Nozzle	Bubble Type Herbicide Vertical 2-head Nozzle	Vertical 2-head Nozzle, Bubble Type Herbicide Nozzle with Cover	
	Type	Forced Air-cooled 2-stroke Gasoline Engine		
	Model	Koshin KC 22-D		
	Total Displacement Volume	22.6 cc		
	Continuous Operation Time	Approx. 50 min		
Net Weight		6.9 kg (15 lbs)	7.1 kg (15.6 lbs)	7.3 kg (16 lbs)
Gross Weight		9.3 kg (20.5 lbs)	9.6 kg (21 lbs)	9.9 kg (22 lbs)
Dimensions LxWxH (mm)		427 x 400 x 505	427 x 400 x 560	440 x 427 x 582
Packing Unit		1		

*Japanese Domestic Model

Optional parts (Common)

Carry for ES series



Model: ESC-1
 For ES-P series, ES series, ES-C series
 Size: 450 x 430 x 900 (LxWxH (mm))
 Hose: ϕ 6 x 20m
 Connection Thread: G 1/4 *Not for 20L tank.

Easy Carry



Optional parts

Small Gun Nozzle (87cm) Model: NZ-870

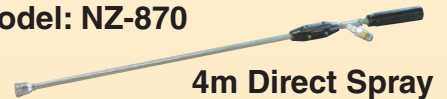

For ES-P series, ES series

Hole Diameter: ϕ 1.2mm,
 Thread Diameter: G 1/4

4m Direct Spray



Twin Piston Type

• Suitable for spraying wide & tall tree
(High Pressure : Twin piston type)

Super-lightweight **4** Stroke engine
6 levels pressure
50L tank

Nozzle length 62~109cm



MS-ERH-50T



MS-ERH50TH85

Super-lightweight **4** Stroke engine
6 levels pressure
25L tank

Nozzle length 87cm



MS-ERH25TH85

Easy Winder



Vertical 2-head nozzle for disinfection



Bubble type herbicide nozzle for herbicide.



4m Direct Spray

Single Nozzle (ERH50TH85)



4m Direct Spray

Nozzle 87m

hole Φ 1.7

Specification

Model		MS-ERH50T*2	MS-ERH50TH85*2	MS-ERH25TH85*2
PUMP	Type	Twin Piston Type		
	Max. Suction Volume	8.6 L/min		
	Spray Volume	1.0 ~ 2.9 L/min	1.1 ~ 4.8 L/min	1.2 ~ 5.4 L/min
	Max. Pressure (at Closing)	3.0 MPa (30 kgf/m ³)		
	Nozzle	Bubble Type Herbicide Double Nozzle, Vertical Type Double nozzle	Bubble Type Herbicide Double Nozzle, Vertical Type Double nozzle, Single Nozzle	Spray & Point Blank Adjust Type
	Delivery Hose	ϕ 6 x 50 m	ϕ 8.5 x 50 m	ϕ 8.5 x 20 m
ENGINE	Type	Forced Air-cooled 4-stroke Gasoline Engine Honda GX25		
	Displacement	25 cc		
	Max. Rated Output/ rpm	0.7 kW (1.0 PS)/ 7000 rpm		
	Fuel	Automotive Unleaded Gasoline		
	Fuel Tank Capacity	Approx. 0.55 L		
	Starting Method	Recoil Starter		
	Operating Time	Approx. 40min		
Net Weight	35 kg (77 lbs)	40 kg (88 lbs)	22 kg (49 lbs)	
Gross Weight	40 kg (88 lbs)	45 kg (99 lbs)	26 kg (57 lbs)	
Dimensions LxWxH (mm)	865 x 580 x 880	865 x 580 x 880	695 x 480 x 640	
Packing Unit	1			

*Suction/ delivery/ remaining water hose, strainer and hose band are included as standard accessories. *2:Japanese Domestic Model

Tank carry

TK-50N

50L tank



Specification

Model	TK-50N*
Tank Capacity	50 L
Dimensions LxWxH (mm)	865 x 580 x 580
	For MS-252R For MS-ERH50 For MS-ERH50TH85 For MS-ERH100

*Japanese Domestic Model

Super-lightweight **4** Stroke engine
 Separate type
6 levels pressure

Nozzle length 62~109cm



Vertical 2-head nozzle for disinfection

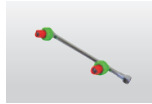

Bubble type herbicide nozzle with cover for herbicide.

Nozzle connection screw type G1/4

4m Direct Spray



Single Nozzle (MS-ERH50H85)



MS-ERH50 (Φ6x50mHose)

Specification

Model		MS-ERH50* (Φ6 x 50m Hose)	MS-ERH100* (Φ6 x 100m Hose)	MS-ERH50H85* (Φ8.5 x 50m Hose)
PUMP	Type	Twin Piston Type		
	Max. Suction Volume	8.6L/min		
	Spray Volume	1.0 ~ 2.9 L/min	1.0 ~ 2.4 L/min	1.1 ~ 4.8 L/min
	Max. Pressure (at Closing)	3.0 MPa (30 kgf/m ²)		
	Nozzle	Bubble Type Herbicide 2-head Nozzle, Vertical Type 2-head Nozzle		Bubble Type Herbicide 2-head Nozzle, Vertical Type 2-head Nozzle, Single Nozzle
Delivery Hose		φ6 x 50 m (with Reel)	φ6 x 100 m (with Reel)	φ8.5 x 50 m (with Reel)
ENGINE	Type	Forced Air-cooled 4-stroke Gasoline Engine Honda GX25		
	Displacement	25 cc		
	Max. Rated Output/ rpm	0.7 kW (1.0 PS) / 7000 rpm		
	Fuel	Automotive Unleaded Gasoline		
	Fuel Tank Capacity	Approx. 0.55 L		
	Starting Method	Recoil Starter		
	Operating Time	Approx. 40 min		
Net Weight		18 kg (40 lbs)	21.5 kg (47 lbs)	23 kg (51 lbs)
Gross Weight		25.5 kg (56 lbs)	29.5 kg (65 lbs)	30.5 kg (67 lbs)
Dimensions LxWxH (mm)		730 x 460 x 435	730 x 460 x 435	700 x 460 x 435
Packing Unit		1		
Accessories		1 Strainer, 2 Suction Hose φ10 x 2.5 m, 1 Remaining water Hose φ8 x 2.5 m, Extendable 2-head Nozzle (62 ~ 109 cm)		

*Japanese Domestic Model

Engine Pressure Washer

Double role for washing & weed removal



8m direct spray

For stuck dirt

4m spray

For washing mud



DM-30

* Spray Gun 76cm

Performance Curve

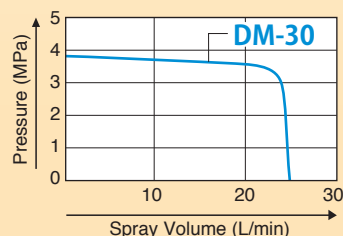

Specification

Model		DM-30*
PUMP	Max. Pressure (at Closing)	3.8 MPa (38 kgf/m ²)
	Max. Suction Volume	25 L/min
	Spray Volume	19 L/min : In case of using *Spray gun (accessory)
	Suction Head	3 m
	Rotations	620 rpm
ENGINE	Engine	Mitsubishi GB131 LN
	Type	Air-cooled 4-stroke Gasoline Engine
	Displacement	126 cc
	Max. Rated Output	3.0 kW (4.2 PS)
	Fuel	Automotive Unleaded Gasoline
	Fuel Tank Capacity	Approx. 2.5 L
	Starting Method	Recoil starter
Operating Time	Approx. 2 hrs	
Accessories		1 Strainer (with Hose band), 1 Suction Hose 3 m (G1), 1 Delivery Hose 10 m, 1 Remaining Water Hose 3 m (G1/2)
Net Weight		41.5 kg (91 lbs)
Gross Weight		52.5 kg (116 lbs)
Dimensions LxWxH (mm)		715 x 700 x 540
Packing Unit		1

*Japanese Domestic Model

Suitable for house garden.

250W motor

25L tank

Integrated type

5 levels pressure



MS-252RT25



■ Nozzle (MS-252RT25/252R)

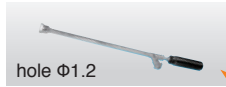

(MS-252CL)



4m Direct Spray

Easy carry. Integrated type.

Nozzle connection screw type G1/4



With reel

MS-252R

250W motor

5 levels pressure

Easy carry.



Tank and carry integrated

MS-252R + TK-50N



Case

MS-252CL

250W motor

5 levels pressure



■ Specification

Model	MS-252RT25* (With 25L Tank, carry)	MS-252R* (With reel)	MS-252CL* (With case)	
PUMP	Pump Type	Single Piston		
	Max. Suction Volume	50 Hz: 3.2 L/min 60Hz: 4.0 L/min		
	Spray Volume	50Hz	2.2 L/min (spray) ~ 2.5 L/min (shot)	
		60Hz	2.7 L/min (spray) ~ 2.9 L/min (shot)	
	Max. Pressure (at Closing)	3.5 MPa (35 kgf/cm ²)		
Nozzle	Spray·Shot Adjustable			
Delivery Hose	Φ6 x 20 M (with Reel)		Φ6 x 20 M	
MOTOR	Motor Type	Single Phase Motor		
	Voltage	AC100 V		
	Frequency	50 / 60 Hz		
	Power Consumption	50 Hz : 350 W 60 Hz : 370 W		
	Output	250 W		
	Max. Current	50 Hz : 6.1 A 60 Hz : 5.3 A		
	Insulation Type	Type E		
	Breaker / Fuse	8 A (Manual)		
	Power Cord	5 M		
Accessories	1 Strainer, 1 Suction Hose Φ10 x 2.5 M, 1 Remaining Water Hose Φ7 x 2.5 M, 1 Delivery Hose Φ6 x 20 M			
Net Weight	23.5 kg (52 lbs)	15.5 kg (34 lbs)	9.5 kg (21 lbs)	
Gross Weight	28 kg (62 lbs)	19.0 kg (42 lbs)	15 kg (33 lbs)	
Dimensions LxWxH (mm)	645 x 480 x 610	585 x 370 x 440	300 x 430 x 261	
Packing Unit	1			

*Japanese Domestic Model

Garden Sprayer Powered by Lithium ion Battery.

New



SLS-7

SLS-10

Smart KOSHIN Battery Series

18V Li-ion

Smart KOSHIN Battery Series

Smart KOSHIN Battery System
*18V battery is interchangeable

- Battery Pack 18V2.0Ah PA-332
- Battery Pack 18V2.5Ah PA-380

High Pressure type

Strong power comparable to engine powered sprayer. Can be used for disinfection for high tree.



SLS-15H

■ Specification

Model	SLS-7*		SLS-10*		SLS-15*		SLS-15H*			
Tank Capacity	7 L		10 L				15 L			
Battery	Lithium-ion Battery 18 V 2.0 Ah									
Recharging time for Battery	70 min									
Pump	Diaphragm Pump									
Max. Pressure (at Closing)	0.3 MPa (3 kgf/cm ²)						1.0 MPa (10 kgf/cm ²)			
Operating Time	Approx. 2.5 hrs						(High mode) Approx. 50 min (Low mode) Approx. 4.5 hrs			
Type	Vertical Type	Bubble Type	Vertical Type	Bubble Type	Vertical Type	Bubble Type	Vertical Type 2-head Nozzle for disinfection		Single Nozzle	
Model	2-head Nozzle	Herbicide Nozzle	2-head Nozzle	Herbicide Nozzle	2-head Nozzle	Herbicide Nozzle	Spray (high)	Spray (low)	Spray (high)	Shot (high)
Total Exhaust										
Suction Volume	0.67 L/min	0.5 L/min	0.67 L/min	0.5 L/min	0.67 L/min	0.5 L/min	1.1 L/min	0.52 L/min	0.7 L/min	1.2 L/min
Pressure	0.26 MPa	0.28 MPa	0.26 MPa	0.28 MPa	0.26 MPa	0.28 MPa	0.75 MPa	0.20 MPa	0.8 MPa	0.7 MPa
Net Weight	3.3 kg (7 lbs)		3.5 kg (8 lbs)		3.6 kg (8 lbs)		3.8 kg (8 lbs)			
Gross Weight	4.4 kg (9 lbs)		5.0 kg (11 lbs)		5.1 kg (11 lbs)		5.4 kg (12 lbs)			
Dimensions LxWxH(mm)	365 × 225 × 475		370 × 247 × 575		370 × 247 × 640		370 × 247 × 640			
Packing Unit	1									

*Japanese Domestic Model

Application for herbicide. Shower type nozzle attached.



DRY CELL BATTERY



DK-7D

With Diaphragm Pump

Long life span. It's hard to stick the chemical



DRY CELL BATTERY

For Herbicide



JS-10

Nozzle length 46cm

Specification

Model	DK-7D*			DK-10D*			JS-10*	
Tank Capacity	7 L						10 L	
Pump	Diaphragm Pump						Impeller Pump	
Motor	DC 7.2 V Motor						DC6 V Motor	
Nozzle	2-head Nozzle		Bubble Type Herbicide Nozzle	2-head Nozzle		Bubble Type Herbicide Nozzle with Cover	For Standard Spray	For Small Amount Spray
Spray Volume	One Head Nozzle : 0.45 L/min	2-head Nozzle : 0.68 L/min	0.55 L/min	One Head Nozzle : 0.45 L/min	2-head Nozzle : 0.68 L/min	0.55 L/min	2.0 L/min	0.7 L/min
Spray Pressure	0.26 MPa	0.16 MPa	0.22 MPa	0.26 MPa	0.16 MPa	0.22 MPa	0.015 MPa(0.15 kgf/cm ²)	
Spray Volume per battery	100 L	160 L	130 L	100 L	160 L	130 L	540 L	190 L
Operating Time	Approx : 4 hrs *Alkaline Battery						Approx. 6 hrs *Alkaline Battery	
Dry Cell Battery	D Type Dry Cell Battery 6 Units (Sold separately)						D Type Dry Cell Battery 4 Units (sold separately)	
Net Weight	3 kg (6 lbs)			3.3 kg (7 lbs)			3 kg (6 lbs)	
Gross Weight	4 kg (9 lbs)			4.7 kg (10 lbs)			4 kg (9 lbs)	
Dimensions LxWxH (mm)	365 x 223 x 435			390 x 247 x 565			365 x 225 x 535	
Packing Unit				1				

*Japanese Domestic Model

Back Pack Type Manual Sprayer

Stable with two belts on chest and waist

Super light



RW-10DX

Nozzle length 60cm

Specification

Model	RW-10DX*	RW-15DX*
Tank Capacity	10 L	15 L
Pump	Diaphragm Pump	
Nozzle	2-head Nozzle 0.9 L/min	Bubble Type Herbicide Nozzle with Cover 0.6 L/min
Max. Pressure	0.4 MPa (4 kgf/cm ²) (at Closing)	
Spray Volume	0.3 MPa (3 kgf/cm ²)	
Net Weight	3.3 kg (7 lbs)	3.7 kg (8 lbs)
Gross Weight	4.5 kg (10 lbs)	5.0 kg (11 lbs)
Dimensions LxWxH (mm)	465 x 225 x 555	465 x 275 x 555
Packing Unit	1	

*Japanese Domestic Model

For Herbicide. Shower Type Nozzle Equipped

Attached nozzle



For Herbicide



JR-20

Specification

Model	JR-20*
Tank Capacity	20 L
Net Weight	1.7 kg (4 lbs)
Gross Weight	2.5 kg (5 lbs)
Dimensions LxWxH (mm)	365 x 235 x 530
Packing Unit	1

*Japanese Domestic Model

Back Pack Type Manual Sprayer Made of Stainless Steel



Lighten the burden when carried on back



Back board equipped

It makes the gap between a body and a tank then make it breathable

■ Specification

Model	SS-10*	SS-15*			
Tank Capacity	10 L	15 L			
Pump	Diaphragm Pump				
Max. Pressure	0.35 MPa (3.5 kgf/cm ²) *at Closing				
PUMP	Nozzle	Vertical 2-head nozzle	Bubble Type Herbicide Nozzle with Cover	Vertical 2-head nozzle	Bubble Type Herbicide Nozzle with Cover
	Spray Volume	0.8 L/min (0.2 MPa)	0.5 L/min (0.2 MPa)	0.8 L/min (0.2 MPa)	0.5 L/min (0.2 MPa)
Spray Pressure	0.8 L/min (0.2 MPa)	0.5 L/min (0.2 MPa)	0.8 L/min (0.2 MPa)	0.5 L/min (0.2 MPa)	
Net Weight	4.6 kg (10 lbs)	4.9 kg (11 lbs)			
Gross Weight	6.3 kg (14 lbs)	6.8 kg (15 lbs)			
Dimensions LxWxH (mm)	440 × 245 × 565	440 × 245 × 635			
Packing Unit	1				

*Japanese Domestic Model

Gargen Sprayer Made of Stainless Steel

■ Specification

Model	SS-4DX*	SS-9DX*
Tank Capacity	4 L	9 L
Nozzle	3 Stage Extendable Nozzle *1 Head	
Nozzle Length	30.5 ~ 73 cm	44 ~ 111 cm
Hose Length	1 m	
Net Weight	1.6 kg (3 lbs)(1 unit)	2.4 kg (5 lbs)(1 unit)
Gross Weight	16.9 kg (37 lbs)(10 units)	12.7 kg (28 lbs)(5 units)
Dimensions LxWxH(mm)	640 × 500 × 380	810 × 300 × 500
Packing Unit	10	5

*Japanese Domestic Model



Manual Sprayer with shoulder belt



■ Specification

Model	SS-5P*
Tank Capacity	5 L
Safety Valve Working Pressure	Approx. 0.4 MPa (4 kgf /cm2)
Nozzle	2 head nozzle (one head switchable) (shot, spray switchable)
Spray Volume	0.6 L/min with 0,3 MPa (2 head nozzle)
Nozzle	0.3 L/min with 0.3 MPa (one head nozzle)
Connection	M 16
Net Weight	1.7 kg (3.7 lbs)
Gross Weight	2.5 kg (5.5 lbs)
Dimensions LxWxH(mm)	365 × 235 × 530
Packing Unit	1

*Japanese Domestic Model

Powered by electric motor

Easy use. Continues high power



GT-10V



■ Specification

Model	GT-5V*	GT-10V*		
Tank Capacity	5 L	10 L		
Pump	Gear Pump			
Max. Pressure	*Approx. 0.26 MPa (2.6 kgf/cm ²) *at Closing			
Nozzle	One Head Nozzle		2-head Nozzle	
	Spray	Shot	Spray	Shot
Spray Volume	0.45 L/min	0.57 L/min	0.68 L/min	0.74 L/min
Spray Pressure	0.26 MPa	0,23 MPa	0.17 MPa	0.15 MPa
Spray Range	Approx. 0.6 m	Approx. 4 m *45 degrees angle	Approx. 0.6 m	Approx. 2.5 m *45 degrees angle
Power Supply	AC100 V (50 Hz,60 Hz), Power Cord 2.5 M			
Net Weight	1.9 kg (4 lbs)	2.4 kg (5 lbs)		
Gross Weight	3.7 kg (8 lbs)	4.4 kg (9.7 lbs)		
Dimensions LxWxH(mm)	200 × 430 × 490	240 × 430 × 490		
Packing Unit	1			

*Japanese Domestic Model



GARDEN SPRAYERS

"Mister AUTO" Manual Pressure Sprayer

- "One hand operation lever"
Easy operation designed for spraying continuously or intermittently.
- 2-stage extendable nozzle
630 – 1135 mm.
- Safety valve with simple pressure gauge.
- Big funnel for easy pouring.



Double Piston Method

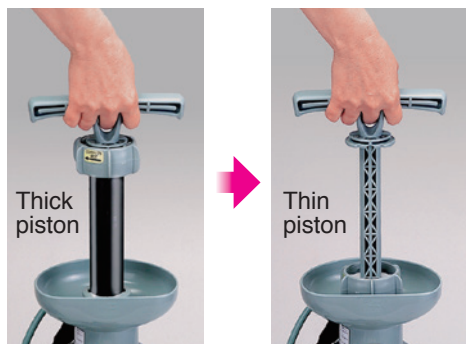

Powerful!

Light!

Switchable Nozzle

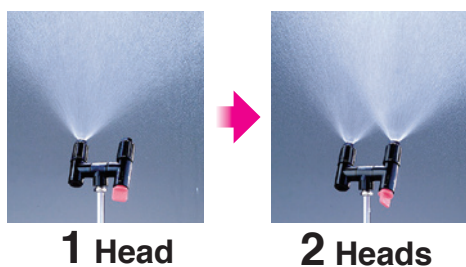

■ Specification

Model	HS-503W*	HS-707W*	HS-401E*
Tank Capacity	5 L	7 L	4 L
Hose Length	5 m (16 ft)		2 m (6.5 ft)
Nozzle Type	2-Stage Extendable 2-Head	4-Stage Extendable 2-Head	1-Head Nozzle
Total Extendable Length	63 – 113.5 cm (24" – 44")	63 – 201 cm (24" – 79")	38 cm (15")
Operating Pressure Around Safety Valve	0.4 MPa (4 kgf/cm ²)		0.2 MPa (2 kgf/cm ²)
Spray Area	56 – 72.7 m ²	79 – 99 m ²	46 – 59 m ²
Net Weight	2.7 kg (5.9 lbs) (1 unit)	2.8 kg (6.17 lbs) (1 unit)	0.96 kg (2.1 lbs) (1 unit)
Gross Weight	13.4 kg (29.5 lbs) (4 units)	14.8 kg (32.6 lbs) (4 units)	8.5 kg (18.7 lbs) (4 units)
Dimensions L×W×H (mm)	441 × 441 × 653	411 × 411 × 653	610 × 410 × 410
Packing Unit	4		6

*Japanese Domestic Model

"Garden Master" Powered by Dry Cell Battery

- Big tank opening for easy cleaning and refilling.
- Internally sloped bottom design ensures all liquids are used up.



GT-3S



Spray
Pump
Cleaning

入
洗

Specification

Model	GT-2S*	GT-3S*	GT-5S*	GT-3HS*	GT-5HS*
Tank Capacity	2 L	3 L	5 L	3 L	5 L
Hose Length	1 m (3.3 ft)	1.5 m (5 ft)		1.7 m (5.6 ft)	
Nozzle Type	1-Stage, 1-Head	3-Stage Extendable, 1-Head		3-Stage Extendable, 1-Head	1-Stage 1-Head, + Extensional
Total Extendable Length	42 cm (16")	43 – 100 cm (16" – 39")		37 – 96 cm (14" – 38")	59 – 96 cm (23" – 38")
Battery	DC 1.5 V × 4 pcs			DC 1.5 V × 6 pcs	
Rating Voltage	4.8 V			7.2 V	
Battery Life	Approx. 20 L (5.3 USG) (Alkaline Battery)	Approx. 70 L (18 USG) (Alkaline Battery) Approx. 30 L (8 USG) (Manganese Battery)		1 Head: Approx. 80 L (21 USG) (Alkaline Battery) 2 Head: Approx. 80 L (21 USG) (Alkaline Battery)	
Spray Volume	Approx. 240 ml/min (Shower Spray) Approx. 400 ml/min (Sharp Spray)	Approx. 240 ml/min (Shower Spray) Approx. 400 ml/min (Sharp Spray)		1 Head: 450 ml/min (Shower Spray), 570 ml/min (Sharp Spray) 2 Head: 680 ml/min (Shower Spray), 740 ml/min (Sharp Spray)	
Shower Spraying Time (Full Tank)	9 min	13 min	21 min	1 Head: 8 min, 2 Head: 5 min	1 Head: 13 min, 2 Head: 8 min
Spray Angle	60 °				
Jet Distance	4 m (13 ft)			1 Head: 6.5 m, 2 Head: 4.5 m	
Standard Accessories	Measurement Cup	1 Spout			
Net Weight	0.62 kg (1.3 lbs) (1 unit)	1.2 kg (2.6 lbs) (1 unit)	1.4 kg (3.8 lbs) (1 unit)	1.3 kg (2.8 lbs) (1 unit)	1.5 kg (3.3 lbs) (1 unit)
Gross Weight	3.8 kg (8.4 lbs) (4 units)	8 kg (17.6 lbs) (4 units)	4.5 kg (9.9 lbs) (2 units)	4.4 kg (9.7 lbs) (2 units)	5.1 kg (11.2 lbs) (2 units)
Dimensions LxWxH (mm)	320 × 320 × 360	540 × 385 × 375	400 × 270 × 375	405 × 385 × 310	405 × 385 × 355
Packing Unit	4			2	

*Japanese Domestic Model

Spreader for Fertilizer

Manual type

Both sowing widely and lineally are adjustable



widely



lineally



Granule Applicator

Spreading amount can be adjustable from small amount to large amount (1~15kg / 10a)

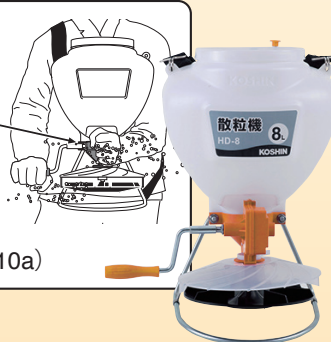

Manual Granule Applicator for Fertilizer



Accessories

Extension pipe x 2

Bellows pipe

Y-shape spray nozzle

parallel spray nozzle

Multi nozzle

Specification

Model	HD-20
Capacity	20 L
Net Weight	1.9 kg (4.1 lbs)(1 unit)
Gross Weight	8.8 kg (19.4 lbs)(3 units)
Dimensions LxWxH(mm)	380 × 160 × 570
Packing Unit	3

Specification

Model	HD-8
Tank Capacity	8 L
Spraying width	5 ~ 7 m
Net Weight	1.9 kg (4.1 lbs)
Gross Weight	2.8 kg (6.1 lbs)
Dimensions LxWxH (mm)	470 × 300 × 280
Packing Unit	1

Specification

Model	HD-5
Tank Capacity	4.6 L
Spraying amount adjusting shutter full open	400 g/min
Net Weight*	2.5 kg (5.5 lbs)
Gross Weight	3.0 kg (6.6 lbs)
Dimensions LxWxH (mm)	300 × 270 × 370
Packing Unit	1

*Bellows pipe, extension pipe and nozzle attached



Smart KOSHIN Battery System

Smart KOSHIN Battery System

**Battery-powered, user-friendly and very quiet.
Cordless and lightweight.**











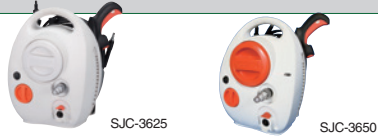









The Smart KOSHIN series is a collection of cordless products that have been designed with ease of use as the top priority.

They are lightweight, have long battery life and use lithium-ion batteries to endure repeated recharges.

The Smart KOSHIN series products can all be used with one battery.



- | Easy operation with one button
- | Safe and easy to use/maintain
- | Powerful and economical
- | No exhaust gas and very quiet

Smart KOSHIN line-up						
		Model	Battery voltage	Battery capacity	Page	
Washer		Washer	SJC-3625		2.5Ah	P68
			SJC-3650		5.0Ah	P68
Garden tool		Pole hedge trimmer	SPH-1820/18N		2.0Ah	P69
		Hedge trimmer	SHT-1820/18N		2.0Ah	P69
		Pole chainsaw	SPS-1820/18N		2.0Ah	P70
		Chainsaw	SCS-3625		2.5Ah	P70
		Blower	SBL-1820/18N		2.0Ah	P71
		Brush cutter	SBC-3650		5.0Ah	P73
			SBC-3650L		5.0Ah	P73
			SBC-1825		2.5Ah	P73
			SBC-1825L		2.5Ah	P73
			SGR-1820		2.0Ah	P73
			SBC-3625C		2.5Ah	P74
		Sprayer	SLS-7		2.0Ah	P61
			SLS-10		2.0Ah	P61
			SLS-15		2.0Ah	P61
			SLS-15H		2.0Ah	P61
		For oil		Drum pump	SFP-2518	

Smart KOSHIN series optional parts



- Battery pack 18V2.0Ah PA-332
- Battery pack 18V2.5Ah PA-380



- Battery pack 36V2.5Ah PA-334
- Battery pack 36V5.0Ah PA-413

Quick charger specs

Fast charger specs		PA-333(18V)	PA-335(36V)
For lithium-ion battery	Model name	PA-332(Capacity2.0Ah)	PA-334(Capacity2.5Ah)
	Voltage	PA-380(Capacity2.5Ah)	PA-413(Capacity5.0Ah)
		DC18V	DC36V

Caution

• All products can share the same battery as long as the voltage (V) is the same. However, when using a battery with a different capacity (Ah) from the standard battery included, operating time and charging time may differ.

Battery-powered high-pressure washer



User-friendly, easy to store and quiet Cordless and easy to use anywhere!

So quiet, your neighbors will never notice
Ranks No. 1 in lowest sound level rate
(60 dB in low mode)

Check product information by video



New



Easy-to-use
SJC-3625



<Accessories>

- Lithium-ion battery
36V/2.5Ah [PA-334](SJC-3625)
36V/5.0Ah [PA-413](SJC-3650)
- 36 V charger [PA335]
- 10 meter high-pressure hose
(one touch coupler on both sides)
- Gun • Long lance • Mist nozzle
- Spin nozzle
- Coupling (on body)

* Equipped with inlet water filter

■ Specification

Model	SJC-3625 *3	SJC-3650 *3
Motor	Brushless motor	
Battery type	Lithium-ion	
Voltage	DC 36 V	
Battery capacity	2.5 Ah	5.0 Ah
Charging time *1	Approx. 90 min	Approx. 180 min
Operating time *2	Low mode: approx. 15 min / high mode: approx. 10 min	Low mode: approx. 30 min / high mode: approx. 20 min
Maximum pressure	7.0 MPa	
Maximum water volume	3.3 L/min (198 L/hr.)	
Water supply	Tap water at room temperature (under 50°C)	
Sound level	(low mode) 60 dB / (high mode) 63 dB	
High-pressure hose length	10 m	
Body size (W x L x H)	300 x 300 x 400	
Net Weight	7.8 kg (17.1 lbs)	8.3 kg (18.2 lbs)
Gross Weight	9.1 kg (20.0 lbs)	9.6 kg (21.1 lbs)
Dimensions LxWxH (mm)	425 x 310 x 420	425 x 310 x 420
Packing Unit	1	

*1 May differ depending on temperature or remaining battery power.

*2 At full charge, no load. *3 Japanese Domestic Model

Cordless and easy to use anywhere

With the water tank, you can use this washer anywhere without water supply or power supply. (self-priming up to 30 cm)
The washer can also be used directly connected to a water supply. (* Water tank sold separately)



Battery-powered washer optional parts for SJC series

Now you can wash where there is no water supply.



Product name	Water tank set
Model	PA-425
Specifications	Hose: 3 m, pressure-resistant Inside diameter 12 mm, outside diameter 17 mm Water bag: Holds up to 18 L

For supplying water from faucet to washer



Product name	Inlet water hose (3 m)
Model	PA-424
Specifications	Hose: 3 m, pressure-resistant Inside diameter 15 mm, outside diameter 20 mm

For washing cars



Product name	Foam nozzle
Model	PA-427
Specifications	Tank volume: 400 mL Detergent: Commercially available neutral detergents

Battery-powered extendable pole hedge trimmer



Reach high spots without a ladder for easy pruning

Easily trim high branches



New



Check product information by video



Specification

Model	SPH-1820 *4	SPH-18N *4
Motor	Brushless motor	
Battery type	Lithium-ion	
Voltage	DC 18V	
Battery capacity	2.0 Ah	
Charging time *1	Approx. 70 min	
Operating time *2	Approx. 50 min	
Trim width	300 mm	
Stroke per minute	1200 rpm*1	
Max trimmable diameter (wood)	18 mm	
Head angle	0-90° (5 steps) (when folded: -180°)	
Body size	1,700~2,200 x 120 x 130	
Accessories	Blade, blade case	
Battery, charger	18 V battery, fast charger	— *3
Net Weight	3.0 kg (6.6 lbs)	2.6 kg (5.7 lbs)
Gross Weight	4.3 kg (9.4 lbs)	3.5 kg (7.7 lbs)
Dimensions LxWxH (mm)	1230 x 145 x 180	1230 x 145 x 180
Packing Unit	1	

Powerful pruner

Trim area at full charge

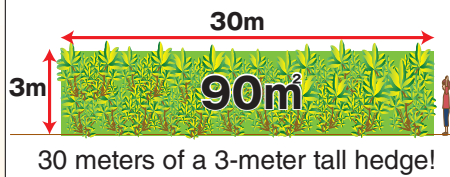

*1 May differ depending on temperature or remaining battery power. *2 At full charge, no load. *3 Battery and charger sold separately: Battery pack 18 V 2.0 Ah (PA-332), Fast charger 18 V (PA-333) *4 Japanese Domestic Model

Battery-powered hedge trimmer



Cordless and easy to use anywhere! No need to worry about accidentally cutting the cord.

Check product information by video



New



Powerful pruner

Trim area at full charge

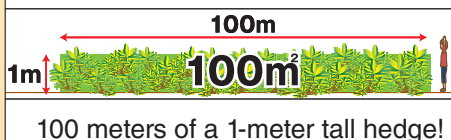

Specification

Model	SHT-1820 *4	SHT-18N *4
Motor	Brushless motor	
Battery type	Lithium-ion	
Voltage	DC 18V	
Battery capacity	2.0 Ah	
Charging time *1	Approx. 70 min	
Operating time *2	Approx. 50 min	
Trim width	350 mm	
Stroke per minute	1200 rpm*1	
Max trimmable diameter (wood)	18 mm	
Body size	805 x 185 x 180	
Accessories	Blade, blade case	
Battery, charger	18 V battery, fast charger	— *3
Net Weight	2.7 kg (5.9 lbs)	2.7 kg (5.9 lbs)
Gross Weight	4.0 kg (8.8 lbs)	3.2 kg (7.0 lbs)
Dimensions LxWxH (mm)	785 x 195 x 195	785 x 195 x 195
Packing Unit	1	

*1 May differ depending on temperature or remaining battery power. *2 At full charge, no load. *3 Battery and charger sold separately: Battery pack 18 V 2.0 Ah (PA-332), Fast charger 18 V (PA-333) *4 Japanese Domestic Model

Battery-powered extendable pole chainsaw



Cut tall trees safely and easily without a ladder !

Cutting tall trees is a breeze!



New



Check product information by video



Can cut approx. 160 branches 38 mm in diameter.

■ Specification

Model	SPS-1820 *4	SPS-18N *4
Motor	Brushless motor	
Battery type	Lithium-ion	
Voltage	DC 18 V	
Battery capacity	2.0 Ah	
Charging time *1	Approx. 70 min	
Operating time *2	Approx. 30 min	
Guide bar length	200 mm	
Chain speed	2.5 m/s	
Head angle	Fixed at 15°	
Adjustable length	1,720–2,300 mm (adjustable extension)	
Body size	1,720 × 100 × 150	
Accessories	Saw chain, guide bar, chain case, chain oil (80 ml), shoulder strap	
Battery, charger	18 V battery, fast charger	— *3
Net Weight	3.3 kg (7.2 lbs)	2.9 kg (6.3 lbs)
Gross Weight	4.7 kg (10.3 lbs)	3.9 kg (8.5 lbs)
Dimensions LxWxH (mm)	1630 × 170 × 145	1520 × 170 × 145
Packing Unit	1	

*1 May differ depending on temperature or remaining battery power. *2 At full charge, no load. *3 Battery and charger sold separately: Battery pack 18 V 2.0 Ah (PA-332), Fast charger 18 V (PA-333) *4 Japanese Domestic Model

Battery-powered chainsaw



Easy to operate and quiet battery-powered chainsaw

Check product information by video



New



■ Specification

Model	SCS-3625 *3
Motor	Brushless motor
Battery type	Lithium-ion
Voltage	DC 36 V
Battery capacity	2.5 Ah
Charging time *1	Approx. 90 min
Operating time *2	Approx. 40 min
Guide bar length	300 mm
Chain speed	8 m/s
Body size	662 × 235 × 274
Accessories	Saw chain, guide bar, chain case, chainsaw oil (115 ml), battery, fast charger
Net Weight	4.5 kg (9.9 lbs)
Gross Weight	6.4 kg (14.1 lbs)
Dimensions LxWxH (mm)	410 × 260 × 290
Packing Unit	1

Number of branches cut at full charge

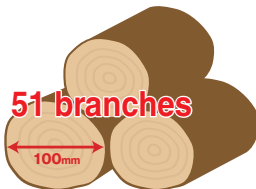

Can cut 51 branches 100 mm in diameter at full charge.



Can cut 300 pieces of lumber sized 40 x 50 mm at full charge.

*1 May differ depending on temperature or remaining battery power. *2 At full charge, no load. *3 Japanese Domestic Model

Battery-powered blower



Multiple uses in one product. Super convenient !



New

- Cleanup after lawn mowing
- Cleanup at construction sites
- Blowing fallen leaves
- Clean storage spaces or behind shelving
- Clean agricultural machinery
- Blow-dry cars after washing

Specification

Model	SBL-1820 *4	SBL-18N *4
Motor	Brushless motor	
Battery type	Lithium-ion	
Voltage	DC 18 V	
Battery capacity	2.0 Ah	
Charging time *1	Approx. 70 min	
Operating time *2	10 min (high) / 20 min (low)	
Maximum air speed	50m/s (high) / 30m/s (low)	
Maximum air flow	2.6 m ³ /min (high) / 1.6 m ³ /min (low)	
Body size	923 × 152 × 195	
Accessories	Nozzle	
Battery, charger	18 V battery, fast charger	— *3
Net Weight	1.5 kg (3.3 lbs)	1.5 kg (3.3 lbs)
Gross Weight	2.6 kg (5.7 lbs)	1.8 kg (1.8 lbs)
Dimensions LxWxH (mm)	520 × 185 × 215	520 × 185 × 215
Packing Unit	1	

Check product information by video

Lightest in the industry

*1 May differ depending on temperature or remaining battery power. *2 At full charge, no load. *3 Battery and charger sold separately: Battery pack 18 V 2.0 Ah (PA-332), Fast charger 18 V (PA-333) *4 Japanese Domestic Model

(Pole) hedge trimmer and (pole) chainsaw optional parts

Photo				
Product name	Blade	Blade	Saw chain	Saw chain
Model	PA-410	PA-411	PA-417	PA-418
Compatible models	SPH Series	SHT Series	SPS Series	SCS-3625
Specifications	300mm	350mm	91PX-33E	90PX-45E

Battery-powered brush cutter

18v Li-ion

36v Li-ion

Chip saw type, from gardening to agricultural use

Both powerful and easy to use

SBC-3650 36V
SBC-1825 18V

Low mode ↔ High mode
Adjustable rotation speed

Detachable



Comes apart for compact storage.



Fits easily into car trunks, portable and convenient.

Easy to grip for those with less hand/grip strength, including women and seniors

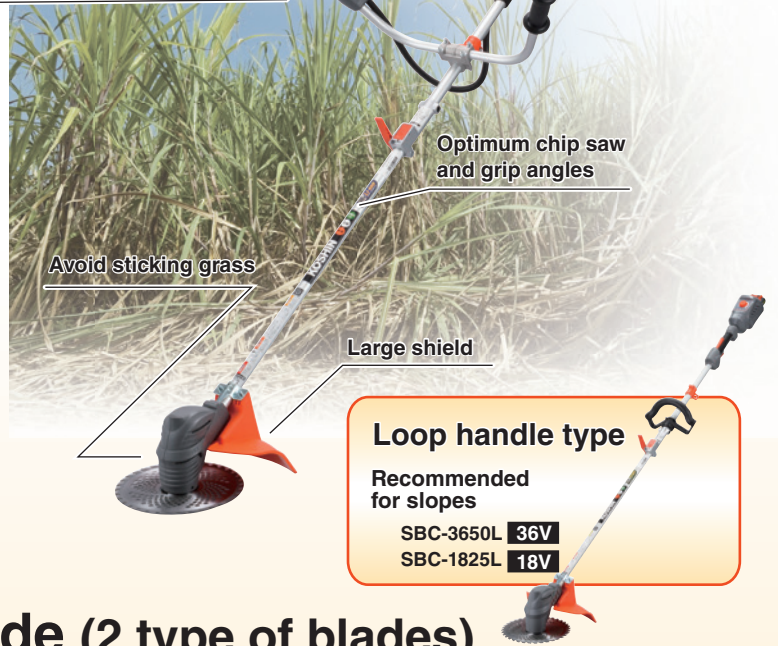

Optimum chip saw and grip angles

Avoid sticking grass

Large shield

Loop handle type

Recommended for slopes

SBC-3650L 36V
SBC-1825L 18V

Chip saw & Resin blade (2 type of blades)

Two different blades for different conditions



[Chip saw]
For overgrown grass or weeds with thick stems

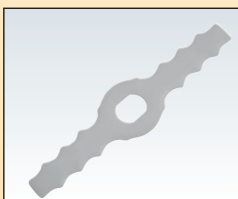

[Resin blade]
For lawns, soft grass and edges

Super-light model
Body weight 1.7 kg

New

Simply grip the handle to operate

Perfect pipe angle and length for keeping arms straight

SGR -1820 18V

The pipe is adjustable to your height

Two different blades for different conditions



Chip saw type (SBC series)

U handle type

Loop handle type

New

Detachable

5 hours on full charge *!

* No load, low mode

SBC-3650



Detachable

High capacity battery for longer operating time

(Compared to former model SBC-3625)

SBC-1825L



New

Chip saw & resin blade (2 types of blades)

SGR-1820



Check product information by video



Chip saw type (SBC series)

■ Specification

Model	SBC-3650 *4	SBC-3650L *4	SBC-1825 *4	SBC-1825L *4	SGR-1820 *4	
Motor	Brushless motor			DC motor		
Battery type	Lithium-ion					
Voltage	DC 36 V			DC 18 V		
Charging time *1	Approx. 70 min			Approx. 90 min	Approx. 60 min	
Operating time *2	High mode	Approx. 100 min			Approx. 30 min	Approx. 35 min
	Low mode	Approx. 300 min			Approx. 50 min	Approx. 35 min
Battery capacity	5.0 Ah			2.5 Ah	2.0 Ah	
Number of revolutions	3000 ~ 6000 rpm			3000 ~ 5000 rpm	(Chip saw) 6300 rpm (Blade) 6600 rpm	
Cutting types	Mowing	Chip saw				2 types (chip saw, resin blade)
Trim diameter	blade *3	230 mm diameter (9 inch)				Both type: 160 mm diameter
Handle	U handle	Loop handle	U handle	Loop handle	Loop handle	
Shaft	Detachable					
Body size	1,880 × 660 × 420		1,880 × 280 × 250		1,850 × 660 × 400	
	Battery side	990 × 660 × 350	990 × 225 × 180	950 × 660 × 330	1,850 × 280 × 250	1,100~1,400
	Motor side	980 × 280 × 240	980 × 280 × 240	950 × 280 × 240	980 × 280 × 240	(Extendable) × 170× 230
Net Weight	5.3kg (11.6 lbs)		5.1kg (11.2 lbs)		4.5kg (9.9 lbs)	4.2kg (9.2 lbs)
Gross Weight	8.0kg (17.6 lbs)		7.7kg (16.9 lbs)		6.7kg (14.7 lbs)	6.4kg (14.1 lbs)
Dimensions LxWxH (mm)	1070 × 290 × 185		1070 × 290 × 185		1010 × 290 × 185	1010 × 290 × 185
Packing Unit	1					
Accessories						Chip saw (blade) 1
						Battery pack 1
	Charger	1	Chip saw (blade)	1	Charger 1	
	Battery pack	1	Nut driver	1	Resin blade 5 blades	
	Shoulder strap	1	Nut wrench	1	Nut driver 1	
						Nut wrench 1

*1 May differ depending on temperature or remaining battery power. *2 At full charge, no load. Operating time may change depending on the brush cutting conditions.

*3 255 mm (10 inch) blades cannot be used. *4 Japanese Domestic Model

Hand carry type battery-powered brush cutter



Less tiring! Easy to use!
Very quiet and perfect for residential neighborhoods!

Easy to store!

The handles and tires fold up, making the model easily stored in a car.



Mowing edge is OK with nylon string

No worries to damage edgestone and garden trees



Check product information by video

Specification

Model	SBC-3625C *3
Motor	Brushless motor
Battery type	Lithium-ion
Voltage	DC 36 V
Battery capacity	2.5 Ah
Charging time *1	Approx. 90 min
Operating time *2	High mode
Guide bar length	Low mode
Number of revolutions	3,000~5,300 rpm
Cutting method	Nylon cutter (nylon cutter + nylon string)
Trim width	360 mm
Nylon string	Cross section: Twisted square (2.4 mm diagonal) Length: 170 mm (including rivet)
Net Weight	7.6 kg (16.7 lbs)
Gross Weight	12 kg (26.4 lbs)
Dimensions LxWxH (mm)	860 x 600 x 265
Packing Unit	1

*1 May differ depending on temperature or remaining battery power.

*2 At full charge, no load. Run time varies depending on the brush cutting conditions.

*3 Japanese Domestic Model

Hand carry type engine brush cutter

Equipped with super-lightweight 4-stroke engine
Fuel efficient and easy to maintain

Easy to start, quiet and user-friendly operation.



Easier to use and less tiring!

Equipped with a 4-stroke engine

Nylon string manual roll-up system

The string length is adjustable, so no need to replace it.



■ Specification

Model	EBC-35C*2
Engine model	KOSHIN K 35
Displacement	35 cc
Engine type	Air cooled 4-stroke gasoline engine
Fuel type	Automotive unleaded gasoline
Fuel tank capacity	Approx. 0.7 L
Continuous operating time	Approx. 50 min
Maximum output	0.81 kW(1.1 PS) / 6500 rpm
Cutting method	Nylon cutter (nylon cutter + nylon string)
Trim width	420 mm
Nylon string	Cross section: square (2.4 mm diagonal) Length: 4 m
Net Weight	10.1 kg (22.2 lbs)
Gross Weight	13.2 kg (29.1 lbs)
Dimensions LxWxH (mm)	895 x 590 x 260
Packing Unit	1

* Differs depending on operational conditions.

*2 Japanese Domestic Model



Check product information by video



Don't get tired after long hours of mowing anymore!

Equipped with a 2-stroke engine

Check product information by video



■ Specification

Model	EBC-26C*2
Engine model	KOSHIN KC 26
Displacement	26 cc
Engine type	Air cooled 2-stroke gasoline engine
Fuel type	2-stroke premix fuel 50:1 (JASO FC or higher)
Fuel tank capacity	Approx. 0.6 L
Continuous operating time	Approx. 35 min (Differs depending on operational conditions)
Maximum output	0.7 kW(0.93 PS) / 7500 rpm
Cutting method	Nylon cutter (nylon cutter + nylon string)
Trim width	420 mm
Nylon string	Cross section: Round shape(3.0 mm diameter) Length: 207 mm (including rivet)
Net Weight	8.9 kg (19.6 lbs)
Gross Weight	12.3 kg (27.1 lbs)
Dimensions LxWxH (mm)	895 x 590 x 260
Packing Unit	1

* Differs depending on operational conditions. *2 Japanese Domestic Model



Make winter life easier with this stable and convenient snow blower.

Engine Snow Blower

Compact but, powerful 11 horsepower snow blower

New



ESB-1170

Check product information by video



- Suitable snow types
- Soft new snow
 - Heavy compacted snow
 - Snow fallen from roofs

54
cm

Maximum snow depth

Clearing width

71
cm

10 min. Clearing width

Approx. **250** m²

On new snow, 20 cm deep

Speedy clearing

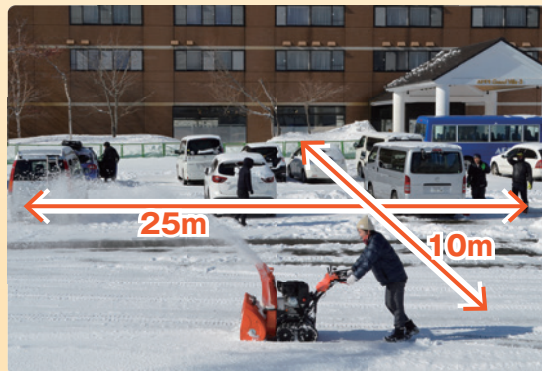

* One unit reaching approx. 2.5 m x 5 m

Works well at slow speeds, making it perfect for femal and senior citizens

Rotating function for tight turns

Simply grip the lever in the direction you wish to turn. This rotation function is not available on competitor snow blowers in this price range.



Moves as slowly as needed!

Equipped with an HST (hydraulic stepless transmission) for smooth and stepless speed control with a single lever.



Throw snow near or far!

The snow throwing chute angle is adjustable with a lever. (two angles)

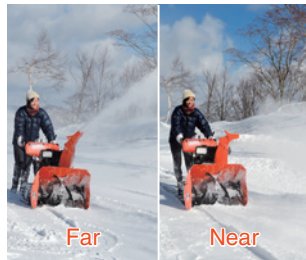

Adjust auger height with a single button!

The auger height can easily be adjusted according to snow depth with a button near the handles.



Mounts maintenance-free battery

Comes with self-priming pump for when the engine does not start

Specification

Model	ESB-1170*	
Clearing capacity	60 t/h	
Snow throwing direction (left/right)	180° (stepless adjusting)	
Snow throwing angle (up/down)	100° (8 stages)	
Engine	Name	Koshin K420DS
	Type	Air-cooled 4-cycle gasoline engine
	Start type	Starter motor (electric), recoil starter (manual)
	Displacement	420 cm ³
	Maximum capacity	8.6 kW (11.7 PS) / 3600 rpm
	Fuel type	Automobile unleaded gasoline
	Run time guideline (at full tank)	Approx. 5 hrs. (no load), approx. 2.5 hrs. (with load)
	Fuel tank capacity	5.2 L
	Oil type	Engine oil (SE or higher) SAE5W-30
	Oil capacity	1.1 L
Body dimensions	1470 x 720 x 1100 mm	
Net Weight	135 kg (297.6 lbs)	
Gross Weight	165 kg (363.7 lbs)	
Dimensions LxWxH (mm)	1500 x 805 x 1140	
Packing Unit	1	

* Japanese Domestic Model

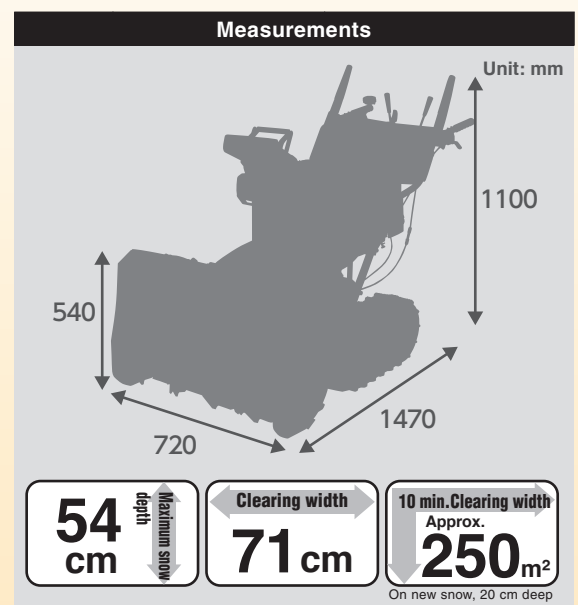

Optional parts for ESB-1170

	For off-season storage	To cut through deep snow	Repair parts			
Product name	Cover	Side cutter	CovAuger sherboltser	Blower sherbolts	Paint for repairs (orange)	Paint for repairs (black)
Model	PA-419	PA-423	PA-420	PA-421	PA-422	PA-428

Battery-powered Snow Remover

Easy clearing with quiet, stable and convenient snow remover

Battery-powered Snow Remover



Check product information by video



■ Suitable snow types

- Soft new snow
- Snow starting to melt
- Heavy compacted snow
- Snow fallen from roofs

SR-350



On new snow, 10 cm deep

Clears snow smoothly
(on wet snow, 11 cm deep)



* One unit reaching approx. 2.5 m x 5 m

Reviews from our customers



It was more powerful than I expected. It is very easy to use and very handy.
Matsumoto City, Nagano



Where it used to take three hours, I can now clear snow in an hour.
Kitahiroshima City, Hokkaido



I am very satisfied because it is quiet and I don't have to bug the neighbors.
Azumino City, Nagano

Perfect for sole proprietors!

Suited to businesses with many female workers, including convenience stores, beauty salons, mobile phone shops, etc.

An easy-to-use, battery-powered blade snow remover. Say goodbye to shoveling snow.

Battery-powered yet powerful!

Compact and battery-powered, yet as powerful as an engine snow remover.



60 cm wide and easily clears narrow spaces!

Oscar's blade is 60 cm, the same as the crawler. It keeps a straight line without wavering for smooth clearing.

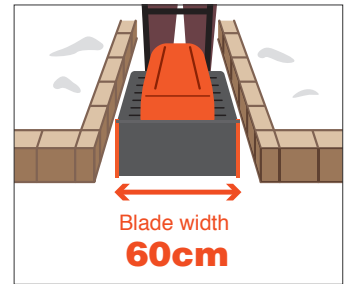

Easy to use and three times as effective!

It advances at a slow walking speed for effective and complete clearing of snow. The lightweight and compact body makes for smooth turns and stable operation.



Low noise for peace of mind!

This snow remover is very quiet so you can work early mornings or weekends without bothering neighbors. The low engine displacement keeps the air clean, perfect for those with small children.



Super easy operation!

Removable and rechargeable battery

Specification

Model	SR-350 *2	
Clearing width	600 mm	
Blade height	320 mm	
Motor	DC motor	
Gear shift type	Gears (1 forward speed, neutral, 1 reverse speed)	
Vehicle speed	Forward speed 2.0 km/h, reverse speed 1.5 km/h	
Battery	Sealed lead-acid battery	
Voltage/Capacity	24 V/20 Ah	
Charging method	Via recharge socket on body and removable battery	
Charger	Power	AC10 0V(50-60 Hz)
	Charging time	Approx. 12 hrs. *1 (At 25°C±5°C room temperature)
Operating time	Approx. 1 hr. *1 (At 0°C temperature)	
Body dimensions	1280 × 630 × 910 mm (Fully assembled size)	
Net Weight	54.0 kg (119.0 lbs)	
Gross Weight	61.0 kg (134.4 lbs)	
Dimensions LxWxH (mm)	975 × 665 × 630	
Packing Unit	1	

*1 Varies under different conditions

*2 Japanese Domestic Model

Measurements

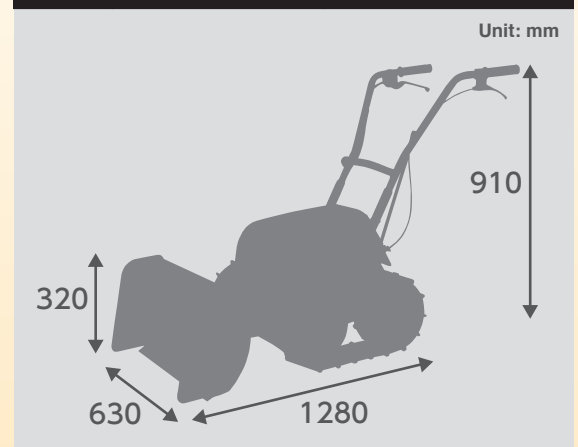

Optional parts for SR-350

	Protects clearing ground	Lifts from clearing ground	Convenient for continuous operation	For off-season storage
Product name	Rubber scraper	Side rollers	Battery	Cover
Model	PA-382	PA-383	PA-379	PA-381

KOSHIN

KOSHIN LTD.

12 Kami-Hachinotsubo, Kotari,
Nagaokakyo city, Kyoto, 617-8511, Japan

✉ Info@koshin-ltd.co.jp

🌐 www.koshinpump.com



*Design and specifications are subject to change without notice.
20-09 699705105

